

Universal Class

SUPER 1600

TRACKED PAVER



Maximum pave width 6.3m
Maximum laydown rate 600 tonnes/h
Transport width 2.55m

CLASSIC
LINE

 www.voegele.info

Robust, powerful and easy to operate



As a paver in the new VÖGELE Classic Line, the SUPER 1600 comes with a very solid range of basic equipment. The most striking feature of this machine is its ErgoBasic operating concept. This system was developed on the basis of the tried-and-tested ErgoPlus 3 operating system and specially tailored to the needs of Classic Line machine users. As with ErgoPlus 3, the design of the paver operator's ErgoBasic console is so clear that all functions can be grasped quickly and operated securely. This is also true of Niveltronic Basic, the System for Automated Grade and Slope Control associated with ErgoBasic. It supports simple and secure operation, contributing to excellent paving results.

All the other components of this tracked paver, such as its drive, undercarriage, conveyors and augers, are identical to those used in Premium Line machines.

The SUPER 1600 is thus also driven by a powerful diesel engine and can reliably tackle all medium to larger paving jobs, delivering top VÖGELE quality across the board.

The AB 480 Extending Screed with tamper and vibrators delivers a high degree of precompaction. With its robust telescoping system, it can be extended hydraulically from 2.55 to 4.8m in a quick and easy operation. With fixed bolt-on extensions, the screed used with the SUPER 1600 can be extended to a maximum pave width of 6.3m.

The VÖGELE Classic Line focuses on the key functions and can hence offer outstanding value for money. This machine is the ideal candidate when classic paving tasks need to be delivered in top quality using tried-and-tested technology.



SUPER 1600

The highlights of the SUPER 1600



Powerful and reliable thanks to the 116kW diesel engine

Powerful and economic drive concept with a modern diesel engine

Simple operation with the innovative and easy-to-grasp ErgoBasic operating system

New and easy-to-use Niveltronic Basic System for Automated Grade and Slope Control

Perfect paving quality due to perfect material management

Easy service concept, perfectly geared to the requirements of the workshop and service staff

Combines with the AB 480 Extending Screenshot in the TV version

SUPER 1600

The drive concept – Efficiency, performance and low consumption

DRIVE CONCEPT



VÖGELE's modern drive concept is perfectly adapted to the large range of different uses of the multifunctional SUPER 1600.

Delivering a powerful drive when maximum performance is called for, this Universal Class paver is exceedingly flexible in everyday operation.

Low input, maximum output – all drive components operate with maximum efficiency, from the diesel engine through to the hydraulic system.

Modern drive technology

Three main components define the power unit of a SUPER 1600: its modern, liquid-cooled diesel engine, a splitter gearbox flanged directly to the engine and a large cooler assembly.

The driving force in this power pack from VÖGELE is its diesel engine. The four-cylinder engine delivers 116kW at 2,000rpm. Yet the fuel-saving ECO mode is sufficient for many applications. And even then, the SUPER 1600 still has a full 106kW at its disposal. Moreover, the machine generates even less noise when running at just 1,700rpm.

A large cooler assembly ensures that the power unit always delivers its full output. With innovative air routing, temperatures are continually maintained within the optimum range, significantly extending

the service life of both the diesel engine and the hydraulic oil. A further advantage is that the machine can operate without difficulty in all climate regions worldwide.

All hydraulic consumers are directly supplied with hydraulic oil via the splitter gearbox. Hydraulic pumps and valves are centrally located, making them optimally accessible for servicing. Even the powerful generator for screed heating is flanged directly onto the splitter gearbox, making it completely maintenance-free.



The large cooler assembly is made up of three parts. It ensures that engine coolant, charge air and hydraulic oil are maintained at the optimum temperature.



Powerful diesel engine develops 116kW at just 2,000rpm.

ECO mode for paver operation with 106kW at 1,700rpm is perfectly adequate for numerous applications. It cuts operating costs and allows superquiet operation.

A powerful, air-cooled generator with direct drive ensures rapid, uniform heating of the screed.



Precision on tracks

High-quality separate hydraulic drives are essential components of the VÖGELE drive concept. They allow our pavers to operate outstandingly and therefore extremely cost-efficiently.

Since the traction drive units are directly integrated into the sprockets of the crawler tracks, engine output is translated into pave speed without any loss of power.



» **The hydraulic systems** for the traction drive, conveyors and augers as well as the compacting systems all operate in separate closed circuits for maximum efficiency.

» **Long crawler tracks** with large footprints provide for maximum tractive effort, allowing the paver to progress well at a constant speed even when operating on difficult terrain.

» **Positive tracking** when moving straight and accurate cornering due to separate drive and electronic control provided for each crawler track.



SUPER 1600

Perfect paving quality due to perfect material management



A continuous flow of mix is key to ensuring uninterrupted and high-quality paving. That is why we attach such importance to professional material management when designing our pavers.

The paver comes with a high-performance hydraulic system. The hydraulics provide an accurate drive for the material handling systems, thus ensuring an optimal head of mix in front of the screed at all times.

The large and sturdy material hopper holds 13t. Thanks to the low and wide hopper sides, feeding the paver with mix is a fast and easy process.

Especially large oscillating push-rollers ensure convenient and shock-free docking of feed vehicles even on bends.

Large material hopper, easy feed with mix

As with all **VÖGELE** pavers, supplying the SUPER 1600 with mix is a clean, safe and swift process.



- » **The large material hopper** holding 13t is amply dimensioned so that a sufficient quantity of mix is stored at all times. There is no problem tiding over difficult situations such as paving under bridges, for instance.
- » **Easy feeding with mix** thanks to low material hopper, wide hopper sides and sturdy rubber baffles fitted to the hopper front.
- » **Especially large oscillating push-rollers** for convenient and shock-free docking of feed vehicles even on bends.

Thanks to the perfect spreading of mix, the SUPER 1600 provides for an optimal head of material in front of the screed in every paving situation.

Powerful, separate hydraulic drives for conveyors and augers are installed achieving high laydown rates up to 600t/h.

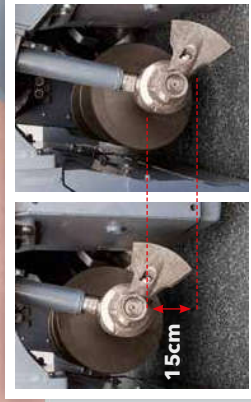

- » **Proportional control and continuous monitoring** provided for conveyors and augers guarantee a constant head of mix in front of the screed in line with requirements.
- » **Large diameter of auger blades** (400mm) for excellent spreading of mix when paving in large widths.
- » **An auger tunnel**, easily variable in depth, provides for an optimal flow of mix when large quantities are being laid.

The augers of the SUPER 1600 are mechanically infinitely height-adjustable by up to 15cm. This enables them to be adapted to the desired layer thickness across the full pave width.

SUPER 1600

The ErgoBasic operating concept

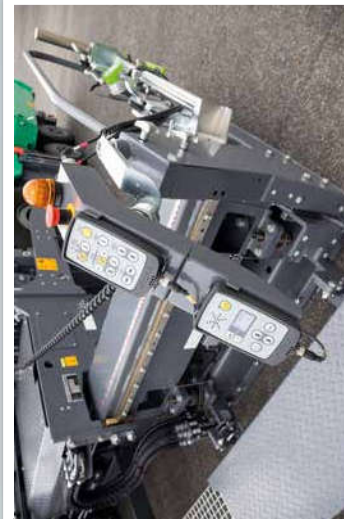

The new **ErgoBasic operating concept** was developed on the basis of the proven ErgoPlus operating system, but it was tailored specifically to the needs and requirements of the users of the VÖGELE Classic Line pavers.

The aim was to develop an operating system that is just as quick, precise and intuitive to operate as the ErgoPlus 3 system for the "Dash 3" machines.

That makes VÖGELE the only manufacturer to offer a standardized operating concept for all paver classes.

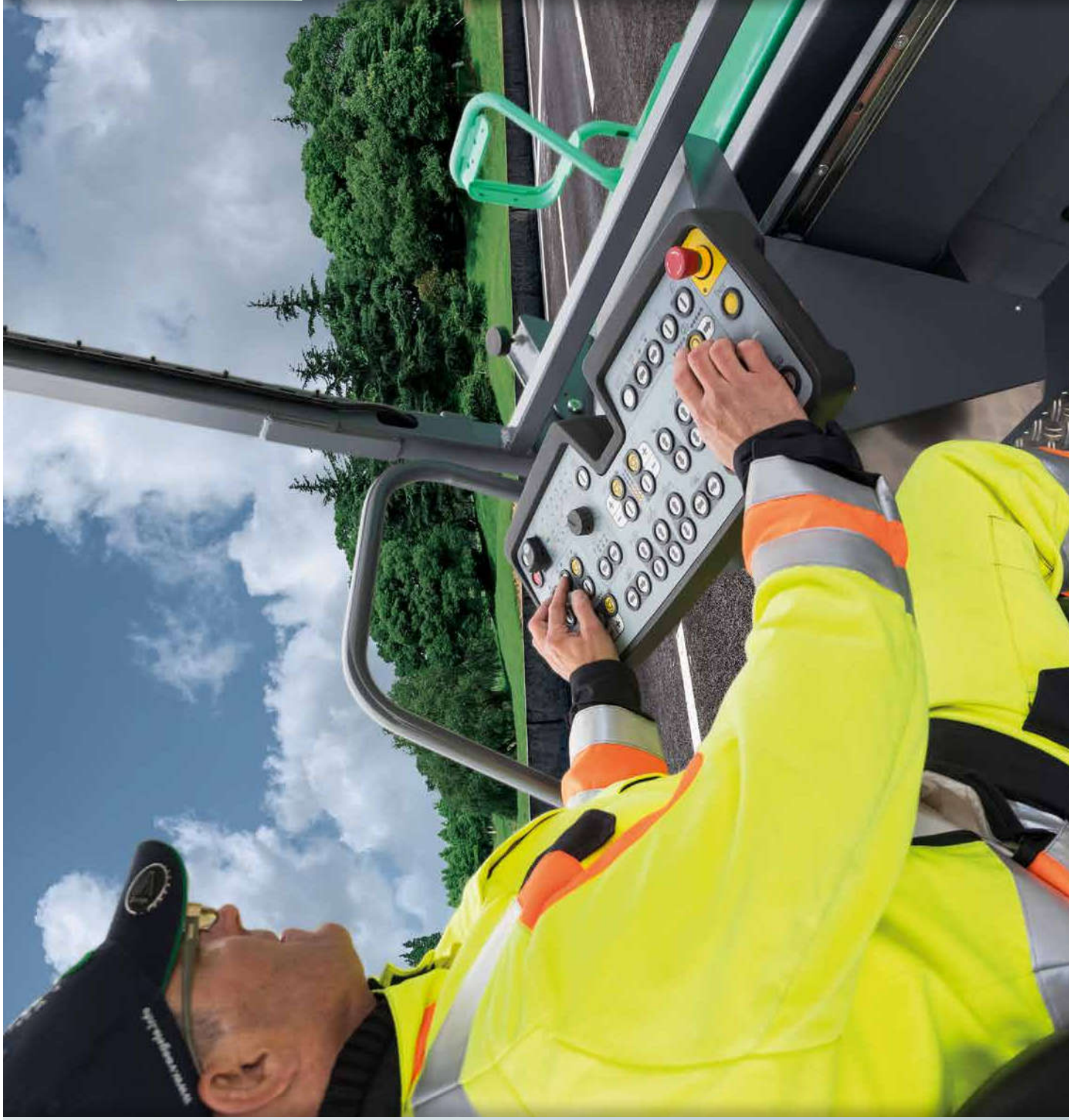

The paver operator's
ErgoBasic console

“Full control for the machine operator!”

The paver operator's ErgoBasic console

Everything at a glance: the functions are arranged in a logical way and are all clearly indicated by a panel that has been designed by the ErgoPlus operating console.

The type of control and the symbols used are all in line with those of an ErgoPlus console.

Given the limited number of functions, there is no need for a display. The status of the console is indicated as at a glance on the LED status panel immediately next to the relevant functions.

LEDs also indicate the set speeds for the augers and the compacting systems as well as the fill level of the fuel tank.

Functions and status indicators
The function and status indicators mean that the operator always has full control over the machine. The status of the console is indicated by LEDs for lock, diesel, and safety functions. The status of the fuel tank is also indicated.

Choice of operating mode for the paver
All the functions of the paver are controlled by the ErgoBasic console. The paver changes between operating modes in the plant of the paver. An LED indicates which mode is selected. On the way, the "over" mode, the paver parameter list used are entered immediately after the paver has started on the job site, for instance.

Speed of the augers
When the paver is operating, the maximum speed of the augers is indicated by the LEDs. The maximum speed of the augers can be set by the operator. The value is displayed as a percentage on the LED display.

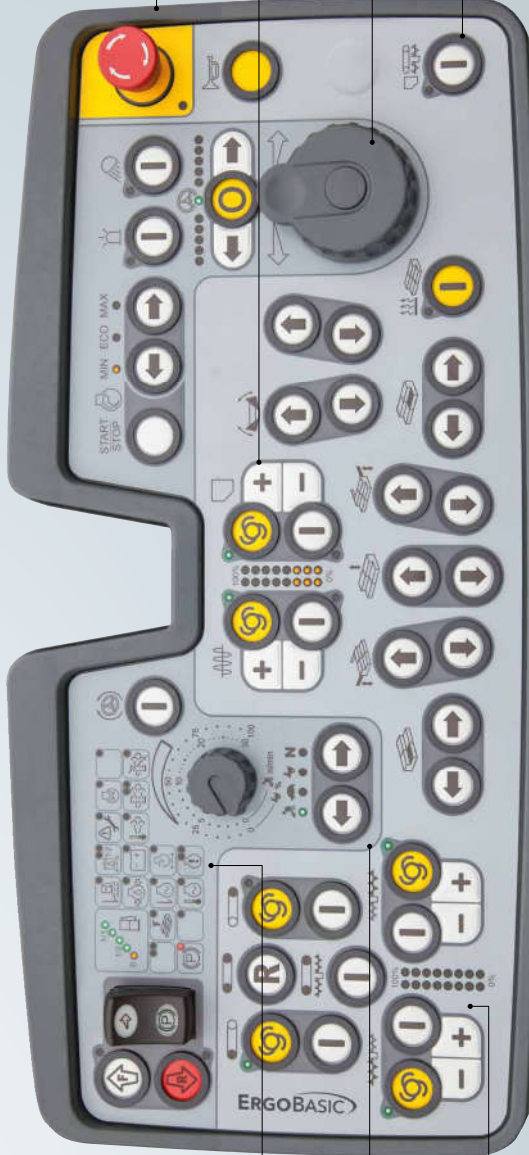

Safe operation during the night
The console is illuminated by LEDs, which means that the operator can see the controls even in the dark. This ensures safe operation during the night.

Compacting effort
The speed of the compacting systems can be set directly on the paver operator's ErgoBasic console. The LED display shows the compacting effort immediately when required.

Steering with protected steering angle
The machine is steered by means of a rotary control. The steering angle is limited by a mechanical stop. For long periods with constant status, the desired steering angle can be set. The function is deactivated following the paver operator's monitor the paver's position and status.

No-load function
The no-load function is provided for the warm-up or clean-up of the augers and the paver.

The ErgoBasic remote control unit for the screed

The **safe and easy handling** of all screed functions is a key factor in high-quality pavement construction. That is why a remote control unit for the screed was developed specifically for the ErgoBasic operating system of the new Classic Line pavers.

The remote control's keypad is laid out logically according to the functional processes. Designed for robustness, it is well able to withstand tough job-site conditions.

Operation is easy to understand and can be learned intuitively in a very short space of time, not least because the symbols used in the proven ErgoPlus operating system are found here, too.

The ErgoBasic remote control unit for the screed allows all paving-related functions to be set quickly and easily. That includes direct access to the material handling systems and the sonic sensor for the auger.

All the **main paving functions** can be controlled via the two handy screed remote control units. Simple, language-neutral symbols allow the machine to be operated intuitively.

1 // Setting: Conveyor (automatic/manual)

2 // Horn

3 // Setting: Auger (automatic/manual)

4 // Screed floating on/off one side

5 // Screed width control,

6 // Adjustment of screed tow point ram



Remote control unit for Niveltronic Basic

VÖGELE have also developed a System for Automated Grade and Slope Control to match the ErgoBasic operating system: the Niveltronic Basic. It is completely integrated into the machine control system and therefore perfectly adapted to the paver model concerned. Another outstanding aspect of Niveltronic Basic is its particularly simple and intuitive handling, a feature which makes it easy even for less experienced operators to learn their way around the system. This creates ideal conditions for the Classic Line pavers to work true to line and level on any base.

Each side of the screen is operated by a separate compact and exceedingly robust Niveltronic Basic remote control unit.

A variety of sensor types is available for Niveltronic Basic, in keeping with the machine's large and varied range of uses. These sensors extend from a mechanical to non-contacting sonic sensors. The System for Automated Grade and Slope Control can simultaneously be connected to two grade sensors and a slope sensor. The type of sensor used is detected automatically.

The kind of reference – ground, tensioned wire or transverse slope – can be easily set on the remote control unit.

The **remote control units** come with all the functions required for high-precision grade and slope control. Clear symbols allow the machine to be operated intuitively.

- 1 // Deviation** from specified values
- 2 // Niveltronic Basic** on/off
- 3 // Setting:** Sensor sensitivity
- 4 // Selecting:** Kind of reference (ground, tensioned wire, transverse slope)
- 5 // Quick set-up**
- 6 // Setting:** Specified value
- 7 // Sensor calibration**





1.



3.

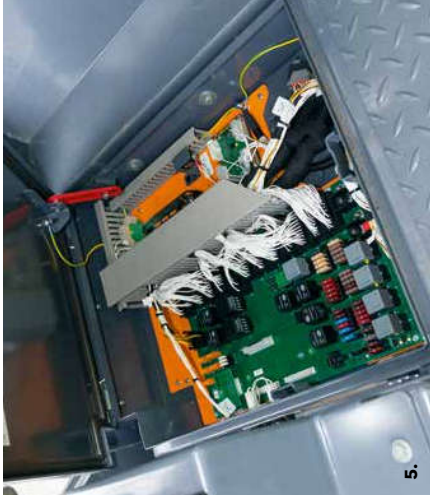

5.



7.



2.



4.



6.



8.

The paver operator's ErgoBasic platform

1. The comfortable paver operator's platform

gives an unobstructed view of all crucial areas on the paver such as material hopper, steering guide or screed. It allows the paver operator to easily monitor the paver's feed with mix, for instance, from his seat.

2. Working comfort

Easy displacement of the paver operator's console across the full width of the platform for convenient working in an ergonomic position on either side of the machine.

3. A place for everything and everything in its place

The paver operator's platform, with its streamlined design, is well organized, offering the paver operator a professional workplace. The paver operator's console can be protected by a shatter-proof cover to prevent wilful damage.

4. Hardtop gives excellent protection

The modern hardtop made of glass fibre reinforced polymer material shelters the operator. The hardtop folds down with effortless ease, thus getting the paver quickly ready for transport.

5. Eco nomic al and service-friendly design

The paver operator has convenient access to all service points on the machine. All hydraulic pumps attached to the splitter gearbox, their clear arrangement and easy access provide for service-friendliness at the highest level. Sturdy components of highly wear-resistant materials for long service lives minimize downtime.

6. Safe and comfortable ascent

The walkway and comfortable middle ascent on the screed ensure safe and convenient access to the paver operator's platform.

7. Safe and easy handling of all screed functions

The ErgoBasic remote control unit for the screed allows all paving-related functions to be set quickly and easily.

8. Easy to use Grade and Slope Control

Each side of the screed is operated by a separate compact and exceedingly robust Niveltronic Basic remote control unit.



AB 480 TV Extending Screed

VÖGELE AB 480 Extending Screed is the preferred choice on all those jobs where pave width varies and prime pavement quality counts. The pave width can be hydraulically adjusted between 2.55m and 4.8m in a fast and simple operation, using the highly stable single-tube telescoping system.

The screed used with the SUPER 1600 can be extended to a maximum pave width of 6.3m by means of fixed bolt-on extensions.

Electric screed heating is provided for all compacting and smoothing screed elements. The electric heating warms the screed up to its operating temperature in next to no time.

The screed for the SUPER 1600



AB 480 TV

Pave widths

- » Infinitely variable range from 2.55m to 4.8m
- » Maximum pave width using bolt-on extensions: > 6.3m (2 x 75cm)

Compacting systems

- » AB 480 TV with tamper and vibrators

AB 480 TV

Built up to maximum pave width

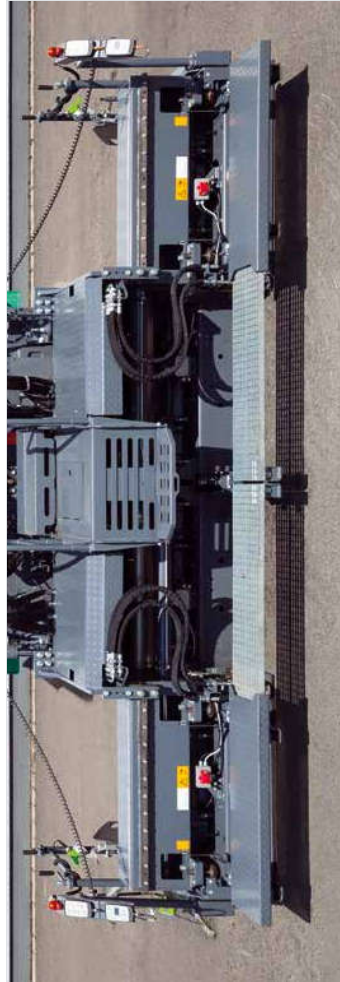
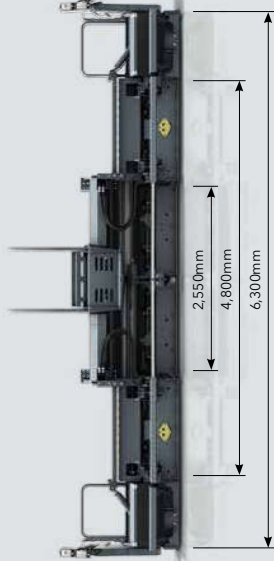

All the facts at a glance



Dimensions in mm

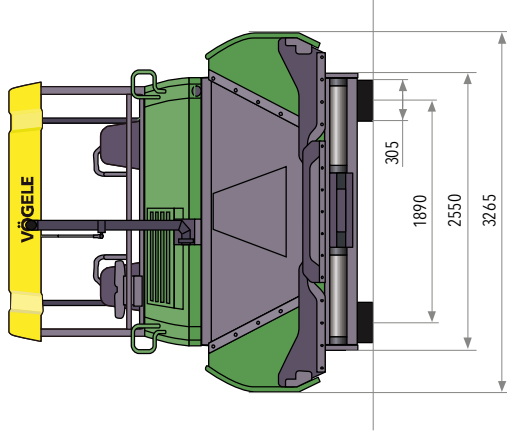
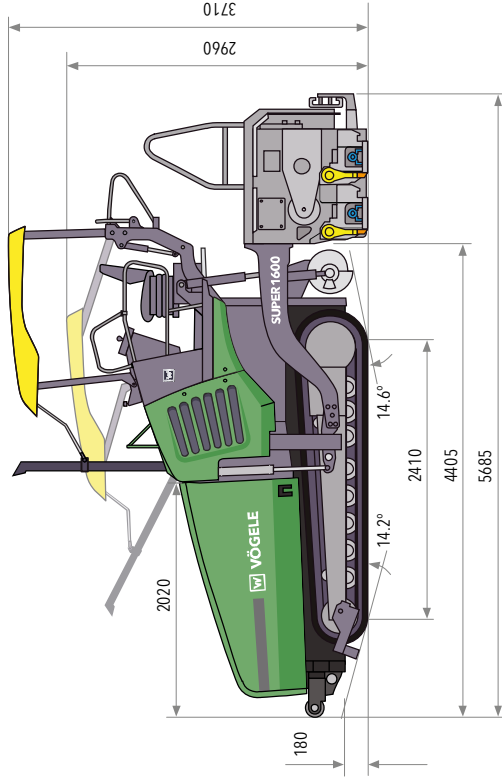

| Power unit | |
|-----------------------------------|---|
| Engine | 4-cylinder diesel engine, liquid-cooled |
| Manufacturer | Commins |
| Type | OSB4-5-C155 |
| Output | 116kW at 2,000rpm (according to DIN) |
| Nominal | 106kW at 1,700rpm |
| ECO mode | |
| Exhaust emissions standard | EU Stage 3a, US EPA Tier 3 |
| Fuel tank | 220 litres |

| Undercarriage | |
|---------------------------------|---|
| Crawler tracks | provided with rubber pads |
| Ground contact | 2,410 x 305mm |
| Track tension adjuster | spring assembly |
| Track roller/lubrication | lifetime |
| Traction drive | separate hydraulic drive and electronic control provided for each crawler track |
| Speeds | |
| Paving | up to 25m/min., infinitely variable |
| Travel | up to 4.5km/h, infinitely variable |
| Material hopper | |
| Hopper capacity | 13t |
| Width | 3,265mm |
| Feed height | 615mm (bottom of material hopper) |
| Push-rollers | |
| Standard | oscillating |
| Position | can be displaced forwards by 75mm or 150mm |

| Conveyors and augers | |
|----------------------|---|
| Conveyors | 2, with replaceable leader bars, conveyor movement reversible for a short time |
| Drive | separate hydraulic drive provided for each conveyor |
| Speed | up to 34m/min., infinitely variable (manual or automatic) |
| Augers | 2, with replaceable auger blades, auger rotation reversible |
| Diameter | 400mm |
| Drive | separate hydraulic drive provided for each auger |
| Speed | up to 84 rpm, infinitely variable (manual or automatic) |
| Height | infinitely variable by 15cm, mechanical, lowest position: 10cm above the ground |
| Lubrication | automatic centralized lubrication system with electrically driven grease pump |

| Screed | |
|-----------------------------------|---|
| AB 480 | basic width 2.55m |
| | infinitely variable range 2.55m to 4.8m |
| | maximum width 0.3m |
| Screed version | TV |
| Layer thickness | up to 30cm |
| Screed heating | electric by heating rods |
| Power supply | three-phase A.C. generator |
| Dimensions (transport) and weight | |
| Length | tractor unit and screed |
| AB 480 TV | 5.67m |
| Weight | tractor unit with screed |
| AB 480 TV | pave widths up to 4.8m |
| | 17,580kg |

Key: AB = Extending Screed TV = with tamper and vibrators

Technical alterations reserved



Your VÖGELE QR Code
will take you directly
to the "SUPER 1600"
on our website.



JOSEPH VÖGELE AG

Joseph-Vögele-Str. 1
67075 Ludwigshafen · Germany
www.voegel.info

T: +49 621 / 81 05 0
F: +49 621 / 81 05 461
marketing@voegel.info



® ERGOPLUS, InLine Pave, NAVITRONIC, NAVITRONIC Basic, NAVITRONIC Plus, NIVELTRONIC, NIVELTRONIC Plus, RoadScan, SprayJet, VÖGELE, VÖGELE PowerFeeder, PaveDock, PaveDock Assistant, AutoSet, AutoSet Plus, AutoSet Basic, ErgoBasic and VÖGELE-EcoPlus are registered Community Trademarks of JOSEPH VÖGELE AG, Ludwigshafen/Rhein, Germany. PCC is a registered German Trademark of JOSEPH VÖGELE AG, Ludwigshafen/Rhein, Germany. ERGOPLUS, NAVITRONIC Plus, NAVITRONIC BASIC, NIVELTRONIC Plus, SprayJet, VISION, VÖGELE, VÖGELE PowerFeeder, PaveDock, PaveDock Assistant, AutoSet, AutoSet Plus, AutoSet Basic and VÖGELE-EcoPlus are trademarks registered in the US Patent and Trademark Office to JOSEPH VÖGELE AG, Ludwigshafen/Rhein, Germany. Legally binding claims cannot be derived from written information or pictures contained in this brochure. Pictures may include optional extras. We reserve the right to make technical or design alterations.