

# KOMATSU®

## PC600/600LC-8R1 BACKHOE PC600/600LC-8R1 LOADING SHOVEL

### HORSEPOWER

Gross:323 kW 433 HP @ 1800 rpm

Net:320 kW 429 HP @ 1800 rpm

### OPERATING WEIGHT

Backhoe:59200–61900 kg

130,510–136,460 lb

Loading shovel:63200–64200 kg

139,330–141,540 lb

**PC**  
**600**



Photo may include optional equipment.

HYDRAULIC EXCAVATOR

# WALK-AROUND

## **Productivity Features**

- **High Work Equipment Speed**  
Increased arm dumping speed and arm speed of compound operation by arm regeneration circuit realize efficient loading operation.
- **Lifting Mode**  
The lifting mode increases the lifting force by 17%.
- **Large Digging Force**  
Pressing the Power Max function button temporarily increases the digging force 8%.
- **Two-mode Setting for Boom**  
Switch selection allows either powerful digging or smooth boom operation.
- **Large Drawbar Pull and Steering Force**  
provide excellent mobility.

See page 5.

## **Excellent Reliability and Durability**

- **Strengthened Boom and Arm**
- **KMAX Bucket** offers superior wear-resistance for specific use in quarry.
- **Removed Water and Contamination in Fuel**
  - Fuel pre-filter with water separator
  - High efficiency fuel filter
  - Water separator
- **O-ring Face Seals**, which have excellent sealing performance, are used for the hydraulic hoses.
- **High-pressure In-line Filtration**  
The cool-running hydraulic system is protected with the most extensive filtration system available, including a high pressure in-line filter for each main pump.
- **Highly Reliable Electronic Devices**  
Exclusively designed electronic devices have passed severe testing.
  - Controller • Sensors • Connectors
  - Heat resistant wiring

See pages 6, 7.

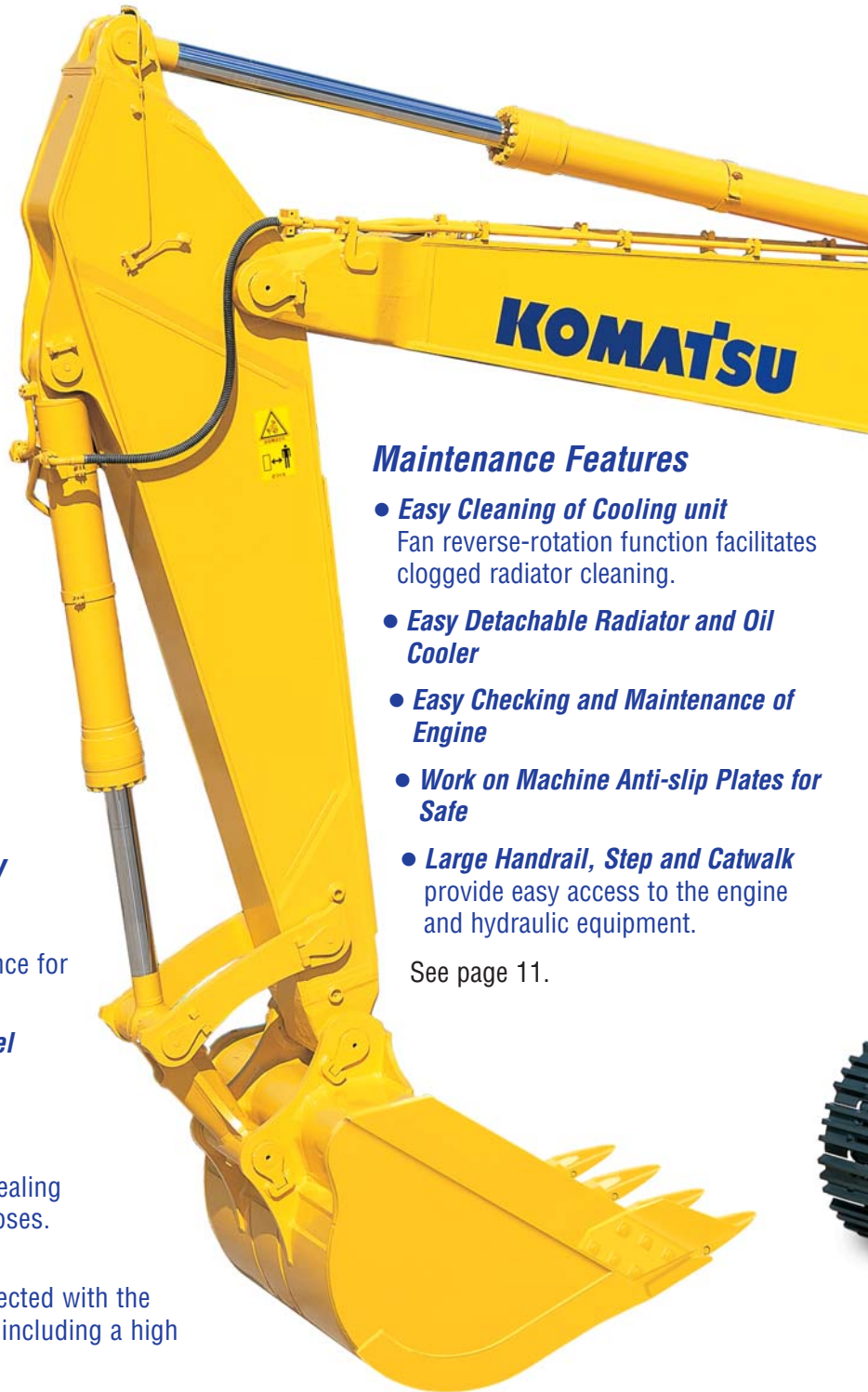

## **Maintenance Features**

- **Easy Cleaning of Cooling unit**  
Fan reverse-rotation function facilitates clogged radiator cleaning.
- **Easy Detachable Radiator and Oil Cooler**
- **Easy Checking and Maintenance of Engine**
- **Work on Machine Anti-slip Plates for Safe**
- **Large Handrail, Step and Catwalk**  
provide easy access to the engine and hydraulic equipment.

See page 11.

## Ecology and Economy Features

### • High Power Komatsu SAA6D140E-5 Engine

A powerful, turbocharged and air-to-air aftercooled Komatsu SAA6D140E-5 provides **320 kW** 429 HP.

### • Economy mode Four-level Setting

Enables operator to select the appropriate Economy mode level to match production requirement with lowest fuel consumption.

### • Low Ambient Noise

- Electronically controlled variable speed fan drive
- Large hybrid fan
- Glasswool-furnished low-noise muffler and noise reducing cover around the muffler

### • Mode Selection

- Economy mode improves fuel consumption.
- Eco-gauge for energy-saving operations
- Extended idling caution for fuel conservation
- Auto deceleration and auto idling system reduce fuel consumption.

See pages 4, 5.



Photo may include optional equipment.

## Working Environment

### • Large Comfortable Cab

- Low-noise cab
- Low vibration with cab damper mounting
- Highly pressurized cab with optional air conditioner
- Operator seat and console with armrest that enables operations in the appropriate operational posture.
- OPG top guard level 2 (by ISO 10262 standard) capable with optional bolt-on top guard

See pages 8, 9.

### Large TFT LCD Monitor

- Easy-to-see and use 7" large multi-function color monitor
- Can be displayed in 12 languages for global support.

TFT : Thin Film Transistor  
LCD : Liquid Crystal Display

See page 10.

### HORSEPOWER

Gross:323 kW 433 HP @ 1800 rpm

Net:320 kW 429 HP @ 1800 rpm

### OPERATING WEIGHT

#### Backhoe

59200 – 61900 kg

130,510 – 136,460 lb

#### Loading shovel

63200 – 64200 kg

139,330 – 141,540 lb

# PRODUCTIVITY & ECOLOGY FEATURES

## Komatsu Technology

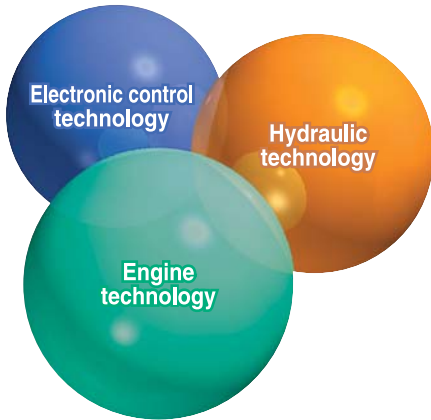

Komatsu develops and produces all major components, such as engines, electronics and hydraulic components, in house. With this “Komatsu Technology,” and adding customer feedback, Komatsu is achieving great advancements in technology. To achieve both high levels of productivity and economical performance, Komatsu has developed the main components with a total control system. The result is a new generation of high performance and environment friendly excavators.

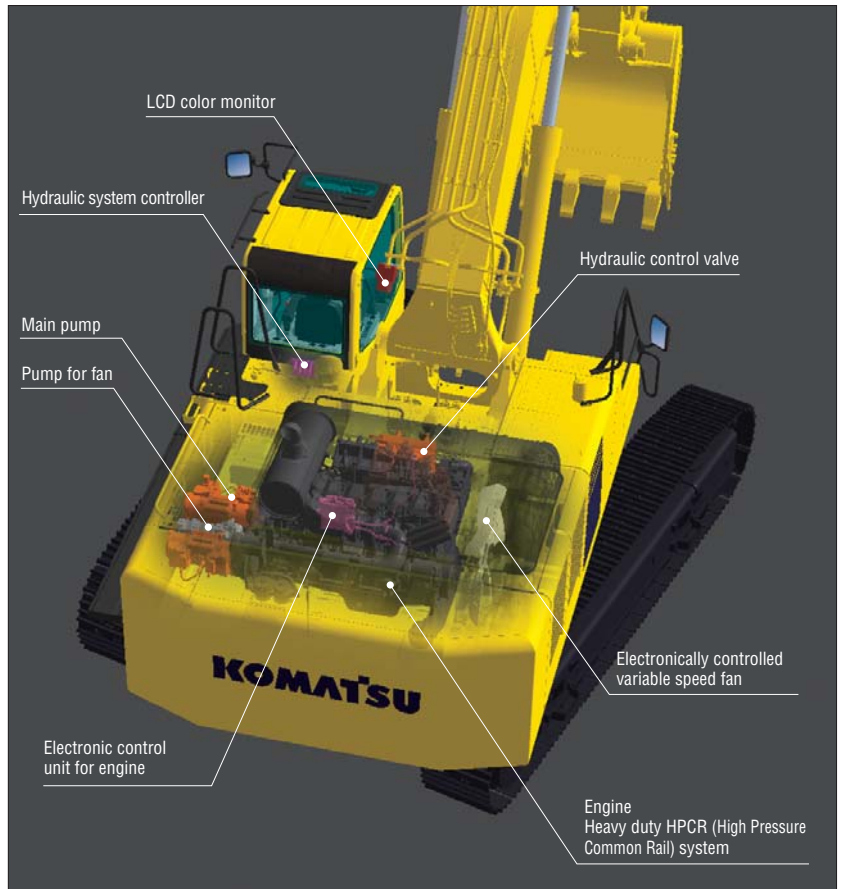

### High Power Komatsu SAA6D140E Engine

Powerful turbocharged and air-to-air aftercooled Komatsu SAA6D140E-5 engine provides 320 kW 429 HP. This Komatsu SAA6D140E engine actualizes high-power to low fuel consumption with the optimum fuel injection by electronic heavy duty HPCR (High Pressure Common Rail) fuel injection system.



### Electronically Controlled Variable Speed Fan Contributes to Low Fuel Consumption and Low Noise

The electronic control system sets the revolution speed of the cooling fan according to the coolant, hydraulic oil, and ambient temperature; effectively uses the engine output to prevent wasteful fuel consumption; and reduces noise during low-speed fan revolution.

### Lower and Economical Fuel Consumption Using Economy Mode

Enables operator to set the Economy mode to four levels according to working conditions so that production requirement is achieved at the lowest fuel consumption.



### Low Ambient Noise

Reduced noise by adoption of an electronically controlled variable speed fan drive, large hybrid fan and low-noise muffler.

**Eco-gauge that Assists Energy-saving Operations**

Eco-gauge is equipped for environment friendly energy-saving operations. Operation in the green range allows reduction of CO<sub>2</sub> emission and fuel consumption.



Eco-gauge

**Idling Caution**

To prevent unnecessary fuel consumption, an idling caution is displayed on the monitor if the engine idles for 5 minutes or more.



**Auto Deceleration and Auto Idling System**

Auto deceleration system is equipped to reduce fuel consumption and operating noise. Also, engine idling speed can be reduced on the monitor with the auto idling system.

**Working Modes Selectable**

P and E work modes are further improved.

**P mode** – Power or work priority mode has low fuel consumption, but fast equipment speed and maximum production and power are maintained.

**E mode** – Economy or fuel saving mode further reduces fuel consumption, but maintains the P-mode-like work equipment speed for light duty work.

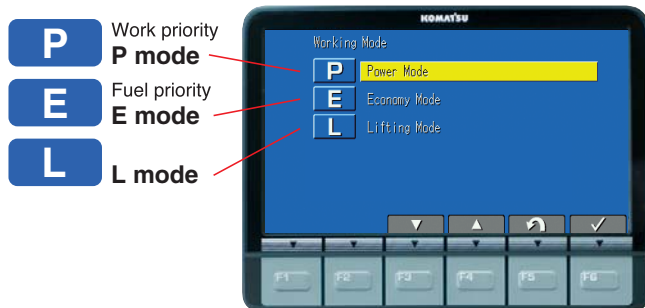

You can select Power or Economy modes using a one-touch button on the monitor panel depending on the workload.

**Large Drawbar Pull and Steering Force**

Since the machine has a large drawbar pull and a high steering force, it demonstrates excellent mobility even when it is on inclined sites.

**Large Digging Force**

With the addition of one-touch Power Max. function digging force is further increased. (8 seconds of operation)

**Maximum arm crowd force (ISO):**  
228 kN (23.3 tonf) ➔ **246 kN (25.1 tonf)** (with Power Max.) **8% UP**

**Maximum bucket digging force (ISO):**  
294 kN (30.0 tonf) ➔ **317 kN (32.3 tonf)** (with Power Max.) **8% UP**

\*Measured with Power Max function, 3500 mm 11'6" arm and ISO rating

**Work Equipment Speed Increased**

Work equipment speed and arm speed of compound operation becomes greater with arm quick return circuit and arm regeneration circuit. Quick loading work is now accomplished.

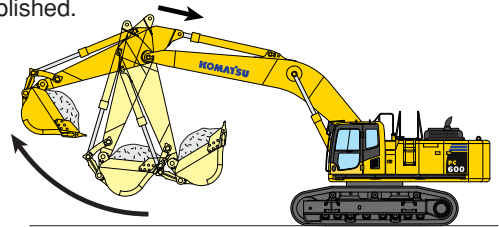

**Two-mode Setting for Boom**

Smooth mode provides easy operation for gathering blasted rock and scraping operations. When maximum digging force is needed, switch to power mode for more effective excavating.

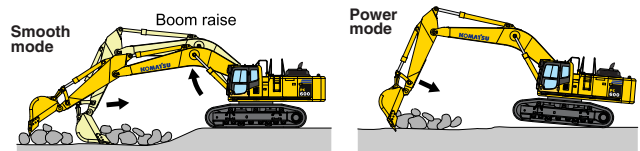

**Lifting Mode**

Gives 17% more lifting force when needed for handling rock or heavy lifting applications.

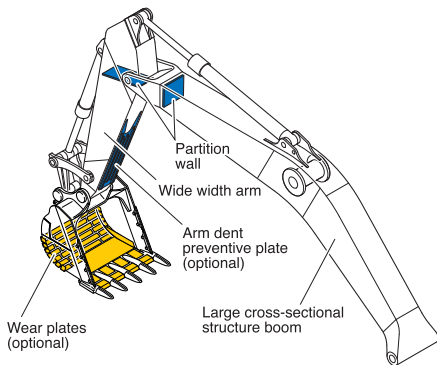

Photo may include optional equipment.

# RELIABILITY FEATURES

## Strengthened Boom and Arm (optional)

Thanks to the large cross-sectional structure employing a high tensile strength steel with a thick plate, partition wall, etc., the boom and arm exhibit excellent durability and are highly resistant to bending and torsional stress.



## O-ring Face Seal

The hydraulic hose seal method has been changed from a conventional taper seal to an O-ring seal. This provides improved sealing performance during operation.

## Frame Structure

The revolving frame mount and center frame mount on the swing circle are no welding structure so that force is transmitted directly to the thick plate of the frame without passing through any welding.

## Fuel Pre-filter (with Water Separator)

Removes water and contaminants from fuel to enhance the fuel system reliability.

## High Efficiency Fuel Filter

Fuel system reliability is even better with high efficiency fuel filter.



Fuel pre-filter

Fuel filter

## High-pressure In-line Filtration

The PC600-8R1 has the most extensive filtration system available, providing in-line filters as standard equipment. An in-line filter in the outlet port of each main hydraulic pump reduces failures caused by contamination.

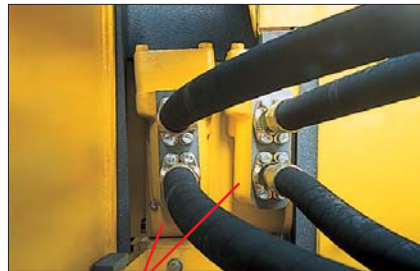

In-line filter

## Metal Guard Rings

Metal guard rings protect all the hydraulic cylinders and improve reliability.

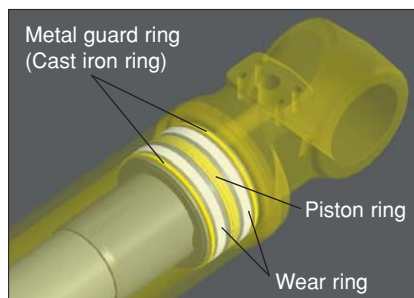

## Heat-resistant Wiring

Heat-resistant wiring is used for the engine electric circuit and other major component circuit.

## Water Separator

Removes water from the fuel and improves the reliability of fuel systems.



## Sturdy Undercarriage

The undercarriage is strengthened to provide excellent reliability and durability when working on rocky ground or blasted rock.

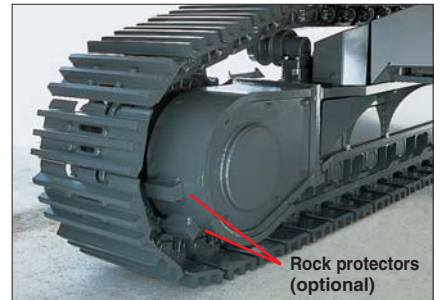

Rock protectors (optional)

**Sturdy guards** shield the travel motors and piping against damage from rocks. (Rock protectors are optional.)

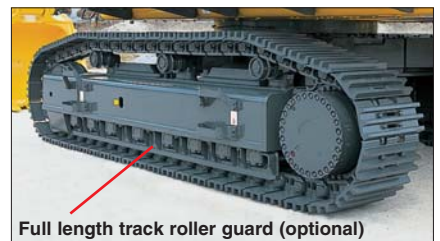

Full length track roller guard (optional)

## Strengthened Revolving Frame Underguard

Guards the machine piping against being hit by rocks from below and prevents hydraulic components and the engine from being damaged.

## DT-type Connectors

DT-type connectors seal tight and have higher reliability.

## Circuit Breaker

With circuit breaker, the machine can be easily restarted after repair.



## Strengthened Quarry Bucket Provides Outstanding Wear-resistance (optional)

The bucket for specific use in quarry is impact and wear resistant, providing high performance and long life. Koma-hard materials\* provide excellent wear resistance. Combined with adoption of long-life KMAX tooth, durability of bucket is drastically enhanced.

\* Koma-hard materials (KVX materials):  
 Komatsu developed, wear-resistant, reinforced materials.  
 Brinell hardness: 500 or more (180kgf/mm<sup>2</sup> class).  
 Features high wear-resistance and little quality change by the heat generated during rock loading, maintaining the hardness for a long term.

### KMAX Tooth

- Unique bucket tooth shape for superior digging performance
- Long-term high sharpness
- Great penetration performance
- Hammerless, safe, and easy tooth replacement  
 (Tooth replacement time: Half of the conventional machine.)

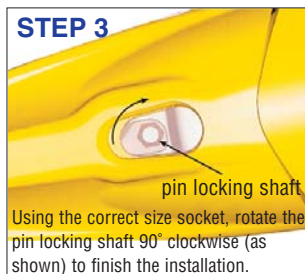
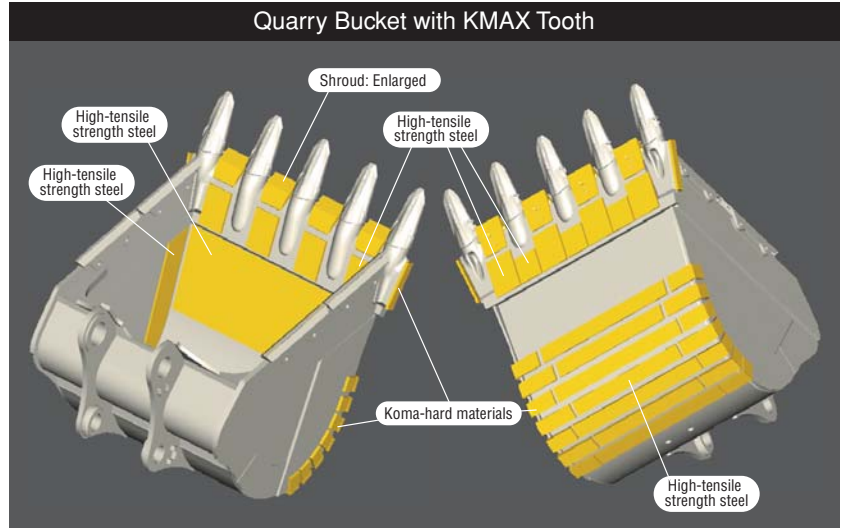

# WORKING ENVIRONMENT



OPG top guard (optional)

Photo may include optional equipment.

## Low Noise Design Cab

The newly-designed cab is highly rigid and has excellent sound absorption ability. Thorough improvement of noise source reduction and use of low noise engine, hydraulic equipment, and air conditioner allows the operator to work in quiet condition.

## Wide Newly-designed Cab

Newly-designed wide spacious cab includes seat with reclining backrest. The seat height and longitudinal inclination are easily adjusted using a pull-up lever. You can set the appropriate operational position of the armrest and the console. The reclining seat further enables you to place it into the fully flat state with the headrest attached.



Seat with headrest reclined full flat

## Pressurized Cab

Optional air conditioner, air filter and a higher internal air pressure (+6.0 mm Aq +0.2"Aq) prevent external dust from entering the cab.



**Multi-position Controls**

The multi-position, PPC (proportional pressure control) levers allow the operator to work in comfort while maintaining precise control. A double-slide mechanism allows the seat and control levers to move together or independently, allowing the operator to position the controls for maximum productivity and comfort.



Seat sliding amount: 340 mm 13.4"

**Low Vibration with Cab Damper Mounting**

PC600-8R1 uses viscous damper mounts for the cab that incorporates longer stroke and the addition of a spring. The cab damper mounting combined with high rigidity deck aids vibration reduction at the operator's seat.

**Automatic Air Conditioner (optional)**

Enables you to easily and precisely set cab atmosphere with the instruments on the large LCD. The bi-level control function keeps the operator's head and feet cool and warm respectively. This improved air flow function keeps the inside of the cab comfortable throughout the year. Defroster function keeps front glass clear.

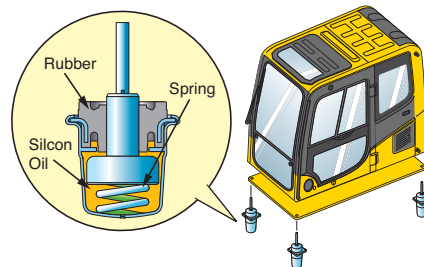
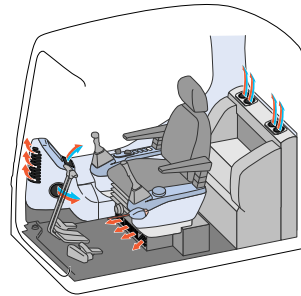

**Cab Equipments**



Skylight



Sliding Window and Large Side Mirror



Defroster (optional)

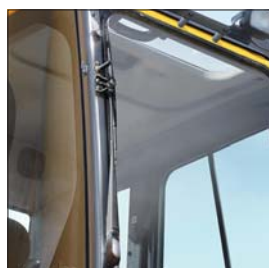

Cab Frame Mounted Wiper



Bottle Holder and Magazine Rack

**Safety Features**

**Step Light with Timer (optional)**

provides light for about one minute to allow the operator to get off the machine safely.

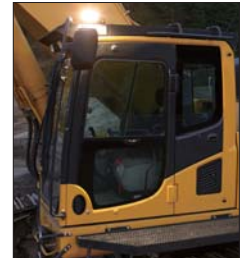

**Pump/engine Room Partition**

prevents oil from spraying on the engine if a hydraulic hose should burst.



**Thermal and Fan Guards**

are placed around high-temperature parts of the engine and fan drive.

**Anti-slip Plates**

Spiked plates on working areas provide anti-slip performance.

**Horn Interconnected with Warning Light (optional)**

gives visual and audible notice of the excavator's operation when activated.



**Rear View Monitoring System (optional)**

The operator can view the rear of the machine with a color monitor screen.



**OPG top guard (optional)**

OPG top guard Level 2 (by ISO 10262) capable with optional bolt-on top guard.

## Large LCD Color Monitor

### Large Multi-lingual LCD Monitor

A large user-friendly color monitor enables safe, accurate and smooth work. Improved screen visibility is achieved by the use of TFT liquid crystal display that can easily be read at various angles and lighting conditions. The switches are simple and easy to operate. Function keys facilitate multi-function operations. Displays data in 12 languages to support operators around the world.



#### Indicators

- |                                  |                                   |
|----------------------------------|-----------------------------------|
| 1 Auto-decelerator               | 5 Hydraulic oil temperature gauge |
| 2 Working mode                   | 6 Fuel gauge                      |
| 3 Travel speed                   | 7 Eco-gauge                       |
| 4 Engine water temperature gauge | 8 Function switches menu          |

#### Basic operation switches

- |                                    |                     |
|------------------------------------|---------------------|
| 1 Auto-decelerator (& auto idling) | 4 Buzzer cancel     |
| 2 Working mode selector            | 5 Wiper             |
| 3 Traveling selector               | 6 Windshield washer |

### Mode Selection

The multi-function color monitor has Power mode (two levels), Economy mode (four levels), and Lifting mode.

Working Mode	Application	Advantage
<b>P</b> (P0,P1)	Power Mode	<ul style="list-style-type: none"> <li>Maximum production/power</li> <li>Fast cycle time</li> </ul>
<b>E</b> (E0,E1,E2,E3)	Economy Mode	<ul style="list-style-type: none"> <li>Good cycle time</li> <li>Good fuel economy</li> </ul>
<b>L</b>	Lifting Mode	<ul style="list-style-type: none"> <li>Hydraulic pressure is increased 17%.</li> </ul>

### EMMS

#### (Equipment Management Monitoring System) Monitor Function

Controller monitors engine oil level, coolant temperature, battery charge and air clogging, etc. If controller finds any abnormality, it is displayed on the LCD.



#### Maintenance Function

Monitor informs replacement time for oil and filters when the replacement interval is reached.

#### Trouble Data Memory Function

Monitor stores abnormalities for effective troubleshooting.



# MAINTENANCE FEATURES

## Easy Checking and Maintenance of Engine

Engine check points are concentrated on one side of the machine to facilitate daily checks. Thermal guards are placed around high-temperature parts such as turbocharger.



## Long-life Oil, Filter

Uses high-performance filtering materials and long-life oil. Extends the oil and filter replacement interval.



Hydraulic oil filter (Eco-white element)

Engine oil & Engine oil filter	every 500 hours
Hydraulic oil	every 5000 hours
Hydraulic oil filter	every 1000 hours

## Electric Pump, Grease Gun with Indicator (optional)

Greasing is made easy with the electric pump and grease gun with indicator.



Indicator Grease gun

## Wide Catwalk

Easier, safer operator cab access and maintenance checks.



## Anti-slip Plates

Spiked plates provided on top of the machine cab maintains anti-slip performance for a prolonged period.

## Easy Cleaning of Cooling Unit

Reverse-rotation function of the hydraulic driven fan simplifies cleaning out the cooling unit.



## Steps Connected to the Machine Cab

Steps allows access from left hand catwalk to top of machine for engine check and maintenance.



## Easy Detachable Radiator and Oil Cooler

Engine hood opens fully to facilitate removal and installation of the radiator and oil cooler. The hood can be opened vertically by changing the position of the torsion bar.



Photo may include optional equipment.

# SPECIFICATIONS



## ENGINE

Model . . . . . Komatsu SAA6D140E-5  
 Type . . . . . Water-cooled, 4-cycle, direct injection  
 Aspiration . . . . . Turbocharged, aftercooled  
 Number of cylinders . . . . . 6  
 Bore . . . . . **140 mm 5.51"**  
 Stroke . . . . . **165 mm 6.50"**  
 Piston displacement . . . . . **15.24 ltr 930 in<sup>3</sup>**  
 Governor . . . . . All-speed, electronic  
 Horsepower:  
   SAE J1995 . . . . . Gross **323 kW 433 HP**  
   ISO 9249 / SAE J1349\* . . . . . Net **320 kW 429 HP**  
 Rated rpm . . . . . 1800 rpm  
 Fan drive type . . . . . Hydraulic  
 \*Net horsepower at the maximum speed of radiator cooling fan is 288 kW 386HP.



## HYDRAULIC SYSTEM

Type . . . . . Open-center load-sensing system  
 Number of selectable working modes . . . . . 3  
 Main pump:  
   Type . . . . . Variable-capacity piston pumps  
   Pumps for . . . . . Boom, arm, bucket, swing, and travel circuits  
 Maximum flow:  
   Main . . . . . **2 x 410 ltr/min** 2 x 108 U.S. gal/min  
 Fan drive pump . . . . . Variable-capacity piston pump  
 Hydraulic motors:  
   Travel . . . . . 2 x axial piston motor with parking brake  
   Swing . . . . . 2 x axial piston motor with swing holding brake  
 Relief valve setting:  
   Implement circuits  
     Backhoe . . . . . **31.9 MPa** 325 kgf/cm<sup>2</sup> 4,620 psi  
     Loading shovel . . . . . **29.4 MPa** 300 kgf/cm<sup>2</sup> 4,270 psi  
   Travel circuit . . . . . **34.3 MPa** 350 kgf/cm<sup>2</sup> 4,980 psi  
   Swing circuit . . . . . **25.5 MPa** 260 kgf/cm<sup>2</sup> 3,700 psi  
   Pilot circuit . . . . . **2.9 MPa** 30 kgf/cm<sup>2</sup> 430 psi

Hydraulic cylinders:  
 (Number of cylinders—bore x stroke x rod diameter)  
 Boom . . . . . **2 – 185 mm x 1725 mm x 120 mm** 7.3" x 67.9" x 4.7"  
 Arm  
   Std. . . . . **1 – 200 mm x 2045 mm x 140 mm** 7.9" x 80.5" x 5.5"  
   SE . . . . . **1 – 200 mm x 2045 mm x 140 mm** 7.9" x 80.5" x 5.5"  
 Bucket  
   Std. . . . . **1 – 185 mm x 1425 mm x 130 mm** 7.3" x 56.1" x 5.1"  
   SE . . . . . **1 – 185 mm x 1610 mm x 130 mm** 7.3" x 63.4" x 5.1"



## DRIVES AND BRAKES

Steering control . . . . . Two levers with pedals  
 Drive method . . . . . Hydrostatic  
 Travel motor . . . . . Axial piston motor, in-shoe design  
 Reduction system . . . . . Planetary gear triple reduction  
 Maximum drawbar pull . . . . . **415kN** 42300 kgf 93,250 lb  
 Gradeability . . . . . 70%  
 Maximum travel speed  
   Low . . . . . **3.0 km/h** 1.9 mph  
   High . . . . . **4.9 km/h** 3.0 mph  
 Service brake . . . . . Hydraulic lock  
 Parking brake . . . . . Oil disc brake



## SWING SYSTEM

Driven method . . . . . Hydrostatic  
 Swing reduction . . . . . Planetary gear  
 Swing circle lubrication . . . . . Grease-bathed  
 Swing lock . . . . . Oil disc brake  
 Swing speed . . . . . 8.3 rpm



## UNDERCARRIAGE

Center frame . . . . . H-leg frame  
 Track frame . . . . . Box-section  
 Seal of track . . . . . Sealed  
 Track adjuster . . . . . Hydraulic  
 No. of shoes . . . . . 49 each side (PC600-8R1)  
                                   52 each side (PC600LC-8R1)  
 No. of carrier rollers . . . . . 3 each side  
 No. of track rollers . . . . . 8 each side (PC600-8R1)  
                                   9 each side (PC600LC-8R1)



## COOLANT AND LUBRICANT CAPACITY (REFILLING)

Fuel tank . . . . . **880 ltr** 232.5 U.S. gal  
 Radiator . . . . . **58 ltr** 15.3 U.S. gal  
 Engine . . . . . **40 ltr** 10.6 U.S. gal  
 Final drive, each side . . . . . **10 ltr** 2.6 U.S. gal  
 Swing drive . . . . . **2 x 13 ltr** 2 x 3.4 U.S. gal  
 Hydraulic tank . . . . . **360 ltr** 95.0 U.S. gal



## OPERATING WEIGHT (APPROXIMATE)

**BACKHOE**  
 Operating weight, including **7660 mm 25'2"** boom, **3500 mm 11'6"** arm, SAE heaped **2.7 m<sup>3</sup> 3.53 yd<sup>3</sup>** backhoe bucket, operator, lubricant, coolant, full fuel tank, and the standard equipment

Shoes	PC600-8R1		PC600LC-8R1	
	Operating Weight	Ground Pressure	Operating Weight	Ground Pressure
Triple grouser 600 mm 24"	<b>59200 kg</b> 130,510 lb	<b>104.9 kPa</b> 1.07 kgf/cm <sup>2</sup> 15.2 psi	<b>60200 kg</b> 132,720 lb	<b>99.0 kPa</b> 1.01 kgf/cm <sup>2</sup> 14.4 psi
<b>750 mm</b> 29.5"	<b>60000 kg</b> 132,280 lb	<b>85.3 kPa</b> 0.87 kgf/cm <sup>2</sup> 12.4 psi	<b>61000 kg</b> 134,480 lb	<b>80.4 kPa</b> 0.82 kgf/cm <sup>2</sup> 11.7 psi
<b>900 mm</b> 35.5"	—	—	<b>61900 kg</b> 136,460 lb	<b>67.7 kPa</b> 0.69 kgf/cm <sup>2</sup> 9.8 psi

**LOADING SHOVEL**  
 Operating weight, including **4000 mm 13'1"** boom, **3000 mm 9'10"** arm, **4.0 m<sup>3</sup> 5.2 yd<sup>3</sup>** heaped bucket, operator, lubricants, coolant, full fuel tank and standard equipment

Shoes	PC600-8R1		PC600LC-8R1	
	Operating Weight	Ground Pressure	Operating Weight	Ground Pressure
Double grouser 600 mm 24"	<b>63200 kg</b> 139,330 lb	<b>111.8 kPa</b> 1.14 kgf/cm <sup>2</sup> 16.2 psi	<b>64200 kg</b> 141,540 lb	<b>105.9 kPa</b> 1.08 kgf/cm <sup>2</sup> 15.4 psi



## DIMENSIONS

	Boom	7660 mm 25'2"	7660 mm 25'2"	7660 mm 25'2"	7300 mm 23'11"	6600 mm 21'8"
	Arm	3500 mm 11'6"	4300 mm 14'1"	5200 mm 17'1"	3500 mm 11'6"	2900 mm 9'6"
A	Overall length	12960 mm 42'6"	12880 mm 42'3"	12585 mm 41'3"	12590 mm 41'4"	11980 mm 39'4"
B	Overall height (to top of boom)	4300 mm 14'1"	4655 mm 15'3"	5235 mm 17'2"	4280 mm 14'1"	4600 mm 15'1"

		PC600-8R1	PC600LC-8R1
C	Overall width	4210 mm 13'10"	4210 mm 13'10"
D	Overall height (to top of cab)	3290 mm 10'10"	3290 mm 10'10"
E	Ground clearance, counterweight	1365 mm 4'6"	1365 mm 4'6"
F	Ground clearance (minimum)	780 mm 2'7"	780 mm 2'7"
G	Tail swing radius	3950 mm 13'0"	3950 mm 13'0"
H	Track length on ground	4250 mm 13'11"	4600 mm 15'1"
I	Track length	5340 mm 17'6"	5690 mm 18'8"
J	Track gauge	2590 mm 8'6"	2590 mm 8'6"
K	Track gauge when expanded	3300 mm 10'10"	3300 mm 10'10"
L	Width of crawler	3190 mm 10'6"	3190 mm 10'6"
M	Width of crawler when expanded	3900 mm 12'10"	3900 mm 12'10"
N	Shoe width	600 mm 24"	600 mm 24"
O	Grouser height	37 mm 1.5"	37 mm 1.5"
P	Machine cab height	3435 mm 11'3"	3435 mm 11'3"
Q	Machine cab width	3170 mm 10'5"	3170 mm 10'5"
R	Distance, swing center to rear end	3825 mm 12'7"	3825 mm 12'7"

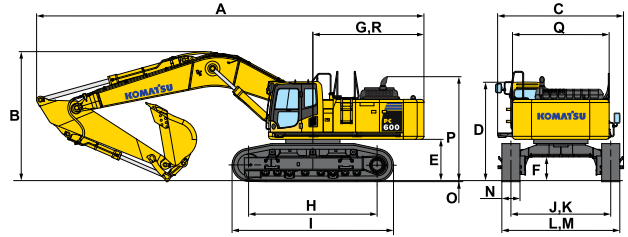

## WORKING RANGE

Unit: mm ft in

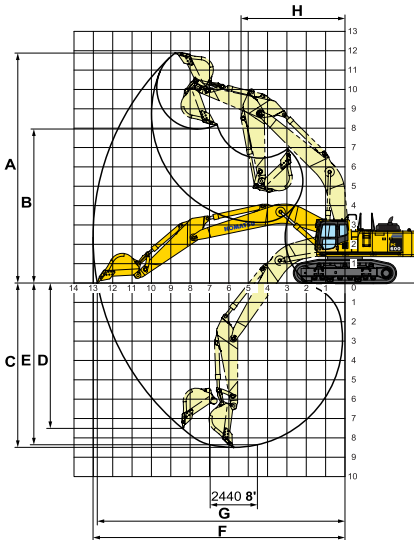

	PC600/600LC-8R1					
	STD		HD		SE	
	Boom	7660 25'2"	7660 25'2"	7660 25'2"	7300 23'11"	6600 21'8"
	Arm	3500 11'6"	4300 14'1"	5200 17'1"	3500 11'6"	2900 9'6"
A	Max. digging height	11880 39'0"	12180 40'0"	12560 41'3"	11475 37'8"	11140 36'7"
B	Max. dumping height	7960 26'1"	8245 27'1"	8600 28'3"	7650 25'1"	7210 23'8"
C	Max. digging depth	8490 27'10"	9275 30'5"	10225 33'7"	8165 26'9"	7060 23'2"
D	Max. vertical wall digging depth	7510 24'8"	8375 27'6"	9275 30'5"	6660 21'10"	5630 18'6"
E	Max. digging depth of cut for 8' level	8360 27'5"	9175 30'1"	10125 33'3"	8030 26'4"	6910 22'8"
F	Max. digging reach	13020 42'9"	13740 45'1"	14630 48'0"	12615 41'5"	11550 37'11"
G	Max. digging reach at ground level	12800 42'0"	13555 44'6"	14435 47'4"	12385 40'8"	11300 37'1"
H	Min. swing radius	5370 17'7"	5385 17'8"	5510 18'1"	5090 16'8"	4670 15'4"
	Bucket digging force (SAE)	264 kN 26900 kgf 59,300 lbf				289 kN 29500 kgf 65,040 lbf
	Bucket digging force at power max. (SAE)	285 kN 29100 kgf 64,150 lbf				312 kN 31770 kgf 70,040 lbf
	Arm crowd force (SAE)	222 kN 22600 kgf 49,820 lb	194 kN 19800 kgf 43,650 lb	170 kN 17300 kgf 38,140 lb	222 kN 22600 kgf 49,820 lb	260 kN 26500 kgf 58,420 lb
	Arm crowd force at power max (SAE)	238 kN 24300 kgf 53,570 lb	209 kN 21300 kgf 46,960 lb	182 kN 18600 kgf 41,010 lb	238 kN 24300 kgf 53,570 lb	280 kN 28500 kgf 62,830 lb
	Bucket digging force (ISO)	294 kN 30000 kgf 66,140 lb				336 kN 34300 kgf 75,620 lb
	Bucket digging force at power max. (ISO)	317 kN 32300 kgf 71,210 lb				362 kN 36900 kgf 81,350 lb
	Arm crowd force (ISO)	228 kN 23300 kgf 51,370 lb	202 kN 20600 kgf 45,410 lb	176 kN 17900 kgf 39,460 lb	228 kN 23300 kgf 51,370 lb	272 kN 27700 kgf 61,070 lb
	Arm crowd force at power max (ISO)	246 kN 25100 kgf 55,340 lb	218 kN 22200 kgf 48,940 lb	189 kN 19300 kgf 42,550 lb	246 kN 25100 kgf 55,340 lb	293 kN 29900 kgf 65,920 lb



## BACKHOE BUCKET AND ARM COMBINATION

BUCKET CAPACITY (HEAPED)				WIDTH				WEIGHT (with side shrouds, side cutters) kg lb	TOOTH	ARM LENGTH m ft in					
SAE, PCSA m <sup>3</sup> yd <sup>3</sup>		CECE m <sup>3</sup> yd <sup>3</sup>		With side shrouds, side cutters mm in		Without side shrouds, side cutters mm in									
use with 7.66m 25'2" boom										3.5	11'6"	4.3	14'1"	5.2	17'1"
2.0	2.62	1.8	2.35	1430	56.3"	1250	49.2"	2130	4,700	KMAX	○	○	○		
2.3	3.01	2.0	2.62	1580	62.2"	1400	55.1"	2260	4,980	KMAX	○	○	—		
2.7	3.53	2.4	3.14	1780	70.1"	1600	63.0"	2470	5,450	KMAX	○	—	—		
use with 7.3m 23'11" HD boom										3.5 11'6" HD arm					
2.8	3.66	2.5	3.27	1655	65.2"	1725	68.0"	3100	6,830	KMAX	○	○	○		
3.1	4.05	2.8	3.66	1780	70.1"	1850	72.9"	3230	7,120	KMAX	○	○*	○		
use with 6.6m 21'8" SE boom										2.9 9'6" SE arm					
3.5	4.58	3.1	4.05	1900	74.9"	1950	76.8"	3330	7,340	KMAX	○	○	○		

These charts are based on over-side stability with fully loaded bucket at maximum reach.

○ : General purpose use, density up to 1.8 t/m<sup>3</sup> 3,000 lb/yd<sup>3</sup>

— : Not useable

\* : Available only to LC crawler



## LOADING SHOVEL DIMENSIONS

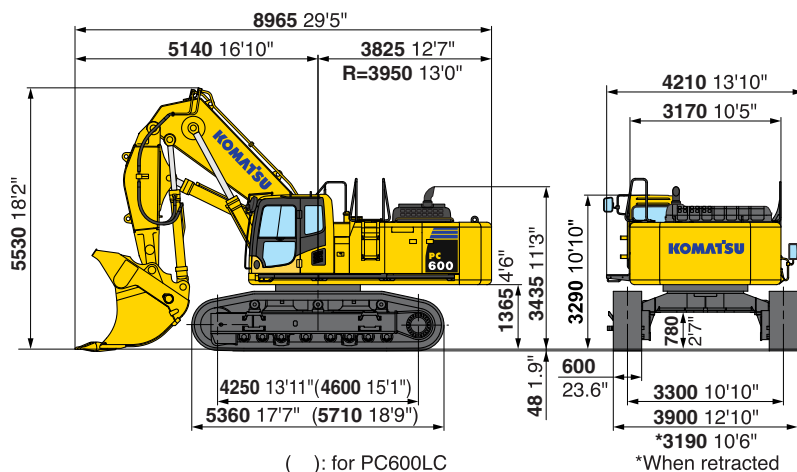

( ) : for PC600LC

\*When retracted



## LOADING SHOVEL WORKING RANGE AND BUCKET SELECTION

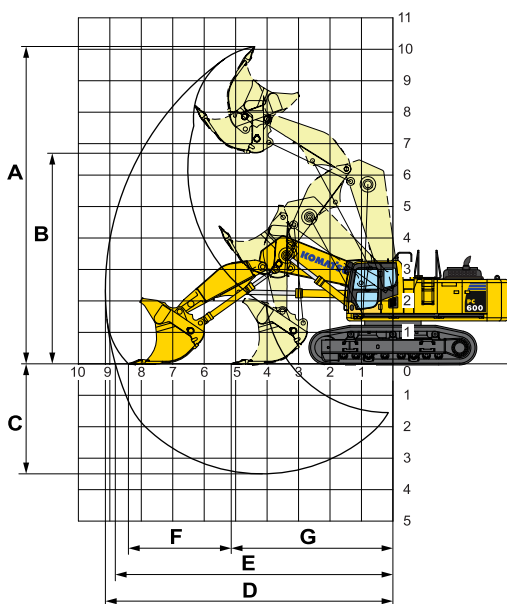

### Working Range

Type of bucket	Bottom dump	
Capacity—heaped	4.0 m <sup>3</sup>	5.2 yd <sup>3</sup>
A Max. cutting height	10090 mm	33'1"
B Max. dumping height	6705 mm	22'0"
C Max. digging depth	3495 mm	11'6"
D Max. digging reach	9190 mm	30'2"
E Max. digging reach at ground level	8850 mm	29'0"
F Level crowding distance	3275 mm	10'9"
G Min. crowd distance	5135 mm	16'10"
Bucket digging force	386 kN	39400 kg 86,860 lb
Arm crowd force	338 kN	34500 kg 76,060 lb

### Bucket Selection

Type of bucket	Bottom dump	
Capacity—heaped	4.0 m <sup>3</sup>	5.2 yd <sup>3</sup>
Width	2090 mm	82.3"
Weight	5700 kg	12,570 lb
No. of bucket teeth	6	
Recommended uses	General-purpose digging and loading	



# LIFTING CAPACITY

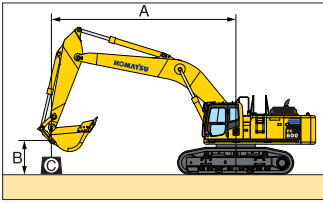

## PC600-8R1

- A: Reach from swing center
- B: Bucket hook height
- C: Lifting capacity
- Cf: Rating over front
- Cs: Rating over side
- ☉: Rating at maximum reach

Boom : 7.66m 25'2", Arm : 3.5m 11'6", Bucket : 2.7m<sup>3</sup> 3.53cu.yd, Shoes : 600mm 24" triple, L mode: "OFF"

unit: kg lb

B	☉ MAX		9.1m 29'		7.6m 24'		6.1m 20'		4.6m 15'		3.0m 9'	
	Cf	Cs	Cf	Cs	Cf	Cs	Cf	Cs	Cf	Cs	Cf	Cs
9.1m 29'	*6950 *15,300	*6950 *15,300										
7.6m 24'	*6750 *14,900	*6750 *14,900	*9400 *20,700	*9400 *20,700								
6.1m 20'	*6850 *15,100	*6850 *15,100	*9700 *21,400	*9700 *21,400	*10800 *23,800	*10800 *23,800						
4.6m 15'	*7100 *15,600	6500 14,300	*10400 *22,900	9450 20,800	*12100 *26,700	*12100 *26,700	*15000 *33,100	*15000 *33,100	*20100 *44,300	*20100 *44,300		
3.0m 9'	*7600 *16,700	6050 13,400	*11250 *24,800	8950 19,800	*13600 *30,000	*12250 27,000	*17850 *39,300	*17400 38,400				
1.5m 4'	7950 17,600	5900 13,100	11350 25,000	8550 18,900	*14800 *32,600	11600 25,600	*19650 *43,300	16450 36,300	*14500 *32,000	*14500 *32,000		
0m 0'	8100 17,900	6000 13,300	11050 24,400	8300 18,300	14850 32,800	11150 24,600	*20200 *44,500	15850 34,900	*16850 *37,100	*16850 *37,100		
-1.5m -4'	8650 19,100	6400 14,100	10850 24,000	8100 17,900	14600 32,200	10900 24,000	*20000 *44,100	15550 34,300	*16550 *36,500	*16550 *36,500	*11950 *26,400	*11950 *26,400
-3.0m -9'	9700 21,400	7200 15,900	10850 24,000	8100 17,900	14550 32,100	10850 23,900	*18950 *41,700	15600 34,400	*24500 *54,000	*24500 *54,000	*14350 *31,600	*14350 *31,600
-4.6m -15'	*10150 *22,400	8900 19,700			*12950 *28,500	11050 24,400	*16650 *36,700	*15900 *35,000	*21150 *46,600	*21150 *46,600	*24800 *54,700	*24800 *54,700
-6.1m -20'	*9500 *21,000	*9500 *21,000			*8550 *18,800	*8550 *18,800	*12800 *28,200	*12800 *28,200	*16300 *35,900	*16300 *35,900		

Boom : 7.66m 25'2", Arm : 3.5m 11'6", Bucket : 2.7m<sup>3</sup> 3.53cu.yd, Shoes : 600mm 24" triple, L mode: "ON"

unit: kg lb

B	☉ MAX		9.1m 29'		7.6m 24'		6.1m 20'		4.6m 15'		3.0m 9'	
	Cf	Cs	Cf	Cs	Cf	Cs	Cf	Cs	Cf	Cs	Cf	Cs
9.1m 29'	*8550 *18,900	*8550 *18,900										
7.6m 24'	*8350 *18,400	*8350 *18,400	*11850 *26,100	10000 22,100								
6.1m 20'	*8450 *18,600	7200 15,900	*12250 *27,000	9800 21,600	*13500 *29,700	*13500 *29,700						
4.6m 15'	8600 19,000	6500 14,300	12250 27,000	9450 20,800	*15100 *33,300	13000 28,700	*18600 *41,000	*18600 *41,000	*24650 *54,300	*24650 *54,300		
3.0m 9'	8100 17,900	6050 13,400	11750 26,000	8950 19,800	*16000 *35,300	12250 27,000	*22100 *48,700	17550 38,700				
1.5m 4'	7950 17,600	5900 13,100	11350 25,000	8550 18,900	*15350 *33,800	11600 25,600	22050 48,600	16450 36,300	*17400 *38,400	*17400 *38,400		
0m 0'	8100 17,900	6000 13,300	11050 24,400	8300 18,300	14850 32,800	11150 24,600	21350 47,100	15850 34,900	*20150 *44,400	*20150 *44,400		
-1.5m -4'	8650 19,100	6400 14,100	10850 24,000	8100 17,900	14600 32,200	10900 24,000	21050 46,400	15550 34,300	*19950 *44,000	*19950 *44,000	*14450 *31,800	*14450 *31,800
-3.0m -9'	9700 21,400	7200 15,900	10850 24,000	8100 17,900	14550 32,100	10850 23,900	21150 46,600	15600 34,400	*30400 *67,100	25750 56,800	*17400 *38,300	*17400 *38,300
-4.6m -15'	11900 26,200	8900 19,700			14800 32,600	11050 24,400	*20900 *46,100	15900 35,100	*26450 *58,300	*26000 *57,300	*29600 *65,300	*29600 *65,300
-6.1m -20'	*12350 *27,300	*12350 *27,300			*11150 *24,600	*11150 *24,600	*16350 *36,000	*16350 *36,000	*20650 *45,600	*20650 *45,600		

Boom : 7.3m 23'11", Arm : 3.5m 11'6", Bucket : 2.8m<sup>3</sup> 3.66cu.yd, Shoes : 600mm 24" triple, L mode: "OFF"

unit: kg lb

B	☉ MAX		9.1m 29'		7.6m 24'		6.1m 20'		4.6m 15'		3.0m 9'	
	Cf	Cs	Cf	Cs	Cf	Cs	Cf	Cs	Cf	Cs	Cf	Cs
9.1m 29'	*6500 *14,300	*6500 *14,300										
7.6m 24'	*6300 *13,900	*6300 *13,900	*8000 *17,600	*8000 *17,600								
6.1m 20'	*6350 *14,000	*6350 *14,000	*9550 *21,000	9400 20,800	*10500 *23,200	*10500 *23,200						
4.6m 15'	*6650 *14,700	*6650 *14,700	*10150 *22,400	9100 20,000	*11750 *25,900	*11750 *25,900	*14500 *32,000	*14500 *32,000	*19900 *43,900	*19900 *43,900		
3.0m 9'	*7200 *15,800	6150 13,600	*11000 *24,200	8650 19,100	*13300 *29,300	12050 26,500	*17350 *38,200	*17350 *38,200	*24100 *53,200	*24100 *53,200		
1.5m 4'	*8000 *17,600	6050 13,300	11050 24,400	8300 18,300	*14500 *32,000	11450 25,200	*19250 *42,500	16500 36,400	*21300 *46,900	*21300 *46,900		
0m 0'	8400 18,500	6150 13,600	10800 23,800	8000 17,700	14700 32,400	11000 24,200	*20000 *44,100	15850 34,900	*14600 *32,100	*14600 *32,100		
-1.5m -4'	9000 19,800	6600 14,600	10650 23,400	7850 17,300	14450 31,800	10750 23,700	*19850 *43,800	15500 34,200	*21100 *46,500	*21100 *46,500	*14000 *30,900	*14000 *30,900
-3.0m -9'	10250 22,600	7600 16,700	10650 23,500	7900 17,400	*14400 *31,700	10700 23,500	*18750 *41,300	15550 34,200	*24750 *54,500	*24750 *54,500	*19650 *43,300	*19650 *43,300
-4.6m -15'	*10350 *22,800	9650 21,300			*12100 *26,700	10900 24,100	*16150 *35,600	*15750 *34,700	*21000 *46,200	*21000 *46,200	*27400 *60,400	*27400 *60,400
-6.1m -20'	*9500 *20,900	*9500 *20,900					*11450 *25,200	*11450 *25,200	*15250 *33,700	*15250 *33,700		

\*Load is limited by hydraulic capacity rather than tipping. Ratings are based on SAE standard NO. J1097. Rated loads do not exceed 87% of hydraulic lift capacity or 75% of tipping load.



# LIFTING CAPACITY

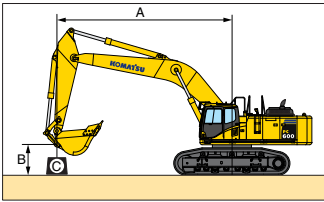

## PC600-8R1

- A: Reach from swing center
- B: Bucket hook height
- C: Lifting capacity
- Cf: Rating over front
- Cs: Rating over side
- ☉: Rating at maximum reach

Boom : 7.3m 23'11", Arm : 3.5m 11'6", Bucket : 2.8m<sup>3</sup> 3.66cu.yd, Shoes : 600mm 24" triple, L mode: "ON"

unit: kg lb

B	☉ MAX		9.1m 29'		7.6m 24'		6.1m 20'		4.6m 15'		3.0m 9'	
	Cf	Cs	Cf	Cs	Cf	Cs	Cf	Cs	Cf	Cs	Cf	Cs
9.1m 29'	*8150 *17,900	*8150 *17,900										
7.6m 24'	*7900 *17,400	*7900 *17,400	*9850 *21,700	9550 21,100								
6.1m 20'	*7950 *17,600	*7450 *16,500	*12150 *26,800	9400 20,800	*13200 *29,100	*13200 *29,100						
4.6m 15'	*8300 *18,300	6650 14,700	11900 26,300	9100 20,000	*14800 *32,600	12750 28,100	*18000 *39,700	*18000 *39,700	*24400 *53,800	*24400 *53,800		
3.0m 9'	8350 18,400	6150 13,600	11450 25,300	8650 19,100	15850 34,900	12050 26,500	*21550 *47,500	17600 38,800	*26500 *58,400	*26500 *58,400		
1.5m 4'	8200 18,100	6050 13,300	11050 24,400	8300 18,300	15200 33,500	11450 25,200	*22150 *48,900	16500 36,400	*23400 *51,600	*23400 *51,600		
0m 0'	8400 18,500	6150 13,600	10800 23,800	8000 17,700	14700 32,400	11000 24,200	*21400 *47,200	15850 34,900	*17800 *39,300	*17800 *39,300		
-1.5m -4'	9000 19,800	6600 14,600	10650 23,400	7850 17,300	14450 31,800	10750 23,700	21050 46,500	15500 34,200	*25450 *56,100	*25450 *56,100	*16950 *37,300	*16950 *37,300
-3.0m -9'	10250 22,600	7600 16,700	10650 23,500	7900 17,400	14400 31,700	10700 23,500	21050 46,500	15550 34,200	*30700 *67,700	*25800 56,900	*23750 *52,400	*23750 *52,400
-4.6m -15'	12950 28,600	9650 21,300			14650 32,300	10900 24,100	*20350 *44,900	15850 34,900	*26250 *57,900	*26100 *57,500	*33500 *73,900	*33500 *73,900
-6.1m -20'	*12450 *27,400	*12450 *27,400					*14750 *32,600	*14750 *32,600	*19500 *43,000	*19500 *43,000		

Boom : 6.6m 21'8", Arm : 2.9m 9'6", Bucket : 3.5m<sup>3</sup> 4.58cu.yd, Shoes : 600mm 24" triple, L mode: "OFF"

unit: kg lb

B	☉ MAX		9.1m 29'		7.6m 24'		6.1m 20'		4.6m 15'		3.0m 9'	
	Cf	Cs	Cf	Cs	Cf	Cs	Cf	Cs	Cf	Cs	Cf	Cs
9.1m 29'	*9650 *21,300	*9650 *21,300										
7.6m 24'	*9050 *20,000	*9050 *20,000			*11550 *25,500	*11550 *25,500						
6.1m 20'	*8950 *19,700	*8950 *19,700			*11750 *25,900	*11750 *25,900						
4.6m 15'	*9200 *20,300	8250 18,100	*11250 *24,800	9000 19,800	*12700 *28,000	*12700 *28,000	*15450 *34,100	*15450 *34,100	*20100 *44,400	*20100 *44,400		
3.0m 9'	*9800 *21,600	7600 16,700	11500 25,300	8650 19,100	*14000 *30,900	12100 26,600	*17950 *39,600	17650 38,900	*24650 *54,300	*24650 *54,300		
1.5m 4'	9950 22,000	7400 16,400	11150 24,600	8350 18,400	*15000 *33,100	11500 25,400	*19750 *43,500	16750 36,900	*26900 *59,400	25900 57,100		
0m 0'	10300 22,700	7650 16,900	10900 24,100	8100 17,900	14850 32,800	11100 24,500	*20250 *44,600	16100 35,500	*26150 *57,700	25000 55,100		
-1.5m -4'	11250 24,800	8400 18,500	10850 24,000	8050 17,800	14650 32,300	10900 24,100	*19800 *43,600	15800 34,900	*26750 *58,900	*25950 *57,200	*18800 *41,500	*18800 *41,500
-3.0m -9'	*11500 *25,400	9950 22,000			*13250 *29,200	11000 24,300	*17950 *39,600	15950 35,100	*23750 *52,400	*23750 *52,400	*24700 *54,500	*24700 *54,500
-4.6m -15'	*10650 *23,500	*10650 *23,500					*13500 *29,800	*13500 *29,800	*18250 *40,300	*18250 *40,300	*23100 *50,900	*23100 *50,900

Boom : 6.6m 21'8", Arm : 2.9m 9'6", Bucket : 3.5m<sup>3</sup> 4.58cu.yd, Shoes : 600mm 24" triple, L mode: "ON"

unit: kg lb

B	☉ MAX		9.1m 29'		7.6m 24'		6.1m 20'		4.6m 15'		3.0m 9'	
	Cf	Cs	Cf	Cs	Cf	Cs	Cf	Cs	Cf	Cs	Cf	Cs
9.1m 29'	*11800 *26,000	*11800 *26,000										
7.6m 24'	*11100 *24,400	*11100 *24,400			*14400 *31,800	13500 29,800						
6.1m 20'	*10950 *24,200	9400 20,700			*14700 *32,400	13300 29,300						
4.6m 15'	10900 24,000	8250 18,100	11800 26,100	9000 19,800	*15900 *35,100	12750 28,200	*19100 *42,100	18950 41,800	*24600 *54,300	*24600 *54,300		
3.0m 9'	10150 22,300	7600 16,700	11500 25,300	8650 19,100	15900 35,100	12100 26,600	*22250 *49,000	17750 39,200	*30350 *66,900	*28050 61,800		
1.5m 4'	9950 22,000	7400 16,400	11150 24,600	8350 18,400	15300 33,700	11500 25,400	22450 49,500	16750 36,900	*26900 *59,400	25900 57,100		
0m 0'	10300 22,700	7650 16,900	10900 24,100	8100 17,900	14850 32,800	11100 24,500	21700 47,900	16100 35,500	*26150 *57,700	25000 55,100		
-1.5m -4'	11250 24,800	8400 18,500	10850 24,000	8050 17,800	14650 32,300	10900 24,100	21400 47,200	15800 34,900	*33050 *72,800	26100 57,600	*22500 *49,600	*22500 *49,600
-3.0m -9'	13350 29,400	9950 22,000			14750 32,500	11000 24,300	21550 47,500	15950 35,100	*29500 *65,100	26450 58,300	*31000 *68,400	*31000 *68,400
-4.6m -15'	*13750 *30,400	*13750 *30,400					*17200 *37,900	*16300 *36,000	*23000 *50,800	*23000 *50,800	*29100 *64,200	*29100 *64,200

\*Load is limited by hydraulic capacity rather than tipping. Ratings are based on SAE standard NO. J1097. Rated loads do not exceed 87% of hydraulic lift capacity or 75% of tipping load.





# LIFTING CAPACITY

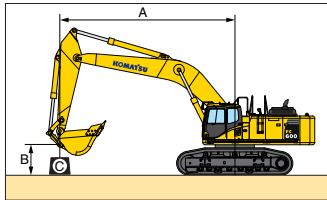

## PC600LC-8R1

- A: Reach from swing center
- B: Bucket hook height
- C: Lifting capacity
- Cf: Rating over front
- Cs: Rating over side
- ☉: Rating at maximum reach

Boom : 7.66m 25'2", Arm : 3.5m 11'6", Bucket : 2.7m<sup>3</sup> 3.53cu.yd, Shoes : 600mm 24" triple, L mode : "OFF" unit: kg lb

B	☉ MAX		9.1m 29'		7.6m 24'		6.1m 20'		4.6m 15'		3.0m 9'	
	Cf	Cs	Cf	Cs	Cf	Cs	Cf	Cs	Cf	Cs	Cf	Cs
9.1m 29'	*6950 *15,300	*6950 *15,300										
7.6m 24'	*6750 *14,900	*6750 *14,900	*9400 *20,700	*9400 *20,700								
6.1m 20'	*6850 *15,100	*6850 *15,100	*9700 *21,400	*9700 *21,400	*10800 *23,800	*10800 *23,800						
4.6m 15'	*7100 *15,600	6650 14,600	*10400 *22,900	9600 21,200	*12100 *26,700	*12100 *26,700	*15000 *33,100	*15000 *33,100	*20100 *44,300	*20100 *44,300		
3.0m 9'	*7600 *16,700	6200 13,700	*11250 *24,800	9150 20,200	*13600 *30,000	*12450 27,500	*17850 *39,300	*17600 *38,900				
1.5m 4'	*8300 *18,400	6050 13,400	*11950 *26,300	8750 19,300	*14800 *32,600	*11800 26,100	*19650 *43,300	*16750 37,000	*14500 *32,000	*14500 *32,000		
0m 0'	9350 20,600	6150 13,600	*12350 *27,200	8450 18,600	*15400 *34,000	11350 25,100	*20200 *44,500	16150 35,600	*16850 *37,100	*16850 *37,100		
-1.5m -4'	9950 22,000	6550 14,500	*12300 *27,100	8300 18,300	*15450 *34,000	11100 24,500	*20000 *44,100	15850 35,000	*16550 *36,500	*16550 *36,500	*11950 *26,400	*11950 *26,400
-3.0m -9'	*10150 *22,400	7400 16,300	*11600 *25,500	8300 18,300	*14800 *32,600	11100 24,400	*18950 *41,700	15900 35,100	*24500 *54,000	*24500 *54,000	*14350 *31,600	*14350 *31,600
-4.6m -15'	*10150 *22,400	9100 20,100			*12950 *28,500	11300 24,900	*16650 *36,700	*16100 *35,500	*21150 *46,600	*21150 *46,600	*24800 *54,700	*24800 *54,700
-6.1m -20'	*9500 *21,000	*9500 *21,000			*8550 *18,800	*8550 *18,800	*12800 *28,200	*12800 *28,200	*16300 *35,900	*16300 *35,900		

Boom : 7.66m 25'2", Arm : 3.5m 11'6", Bucket : 2.7m<sup>3</sup> 3.53cu.yd, Shoes : 600mm 24" triple, L mode : "ON" unit: kg lb

B	☉ MAX		9.1m 29'		7.6m 24'		6.1m 20'		4.6m 15'		3.0m 9'	
	Cf	Cs	Cf	Cs	Cf	Cs	Cf	Cs	Cf	Cs	Cf	Cs
9.1m 29'	*8550 *18,900	*8550 *18,900										
7.6m 24'	*8350 *18,400	*8350 *18,400	*11850 *26,100	10200 22,500								
6.1m 20'	*8450 *18,600	7350 16,200	*12250 *27,000	10000 22,000	*13500 *29,700	*13500 *29,700						
4.6m 15'	*8750 *19,300	6650 14,600	*13100 *28,900	9600 21,200	*15100 *33,300	13250 29,200	*18600 *41,000	*18600 *41,000	*24650 *54,300	*24650 *54,300		
3.0m 9'	9300 20,500	6200 13,700	*13450 29,600	9150 20,200	*17000 *37,500	12450 27,500	*22100 *48,700	17850 39,400				
1.5m 4'	9150 20,200	6050 13,400	13000 28,700	8750 19,300	17600 38,800	11800 26,100	*24350 *53,700	16750 37,000	*17400 *38,400	*17400 *38,400		
0m 0'	9350 20,600	6150 13,600	12700 28,000	8450 18,600	17100 37,700	11350 25,100	24800 54,600	16150 35,600	*20150 *44,400	*20150 *44,400		
-1.5m -4'	9950 22,000	6550 14,500	12500 27,600	8300 18,300	16700 37,100	11100 24,500	24450 54,000	15850 35,000	*19950 *44,000	*19950 *44,000	*14450 *31,800	*14450 *31,800
-3.0m -9'	11150 24,600	7400 16,400	12500 27,600	8300 18,300	16800 37,000	11100 24,400	*23650 *52,100	15900 35,100	*30400 *67,100	26200 57,800	*17400 *38,300	*17400 *38,300
-4.6m -15'	*13000 *28,700	9100 20,100			*16400 *36,100	11300 24,900	*20900 *46,100	16200 35,800	*26450 *58,300	*26450 *58,300	*29600 *65,300	*29600 *65,300
-6.1m -20'	*12350 *27,300	*12350 *27,300			*11150 *24,600	*11150 *24,600	*16350 *36,000	*16350 *36,000	*20650 *45,600	*20650 *45,600		

Boom : 7.3m 23'11", Arm : 3.5m 11'6", Bucket : 2.8m<sup>3</sup> 3.66cu.yd, Shoes : 600mm 24" triple, L mode : "OFF" unit: kg lb

B	☉ MAX		9.1m 29'		7.6m 24'		6.1m 20'		4.6m 15'		3.0m 9'	
	Cf	Cs	Cf	Cs	Cf	Cs	Cf	Cs	Cf	Cs	Cf	Cs
9.1m 29'	*6500 *14,300	*6500 *14,300										
7.6m 24'	*6300 *13,900	*6300 *13,900	*8000 *17,600	*8000 *17,600								
6.1m 20'	*6350 *14,000	*6350 *14,000	*9550 *21,000	*9550 *21,000	*10500 *23,200	*10500 *23,200						
4.6m 15'	*6650 *14,700	*6650 *14,700	*10150 *22,400	9250 20,400	*11750 *25,900	*11750 *25,900	*14500 *32,000	*14500 *32,000	*19900 *43,900	*19900 *43,900		
3.0m 9'	*7200 *15,800	6300 13,900	*11000 *24,200	8850 19,500	*13300 *29,300	12250 27,000	*17350 *38,200	*17350 *38,200	*24100 *53,200	*24100 *53,200		
1.5m 4'	*8000 *17,600	6150 13,600	*11650 *25,700	8450 18,700	*14500 *32,000	11650 25,700	*19250 *42,500	16800 37,100	*21300 *46,900	*21300 *46,900		
0m 0'	*9200 *20,300	6300 13,900	*12050 *26,600	8200 18,100	*15150 *33,400	11200 24,700	*20000 *44,100	16150 35,600	*14600 *32,100	*14600 *32,100		
-1.5m -4'	*10200 *22,400	6800 14,900	*11900 *26,300	8050 17,700	*15150 *33,400	10950 24,100	*19850 *43,800	15800 34,900	*21100 *46,500	*21100 *46,500	*14000 *30,900	*14000 *30,900
-3.0m -9'	*10350 *22,900	7750 17,100	*10900 *24,100	8050 17,800	*14400 *31,700	10900 24,000	*18750 *41,300	15850 34,900	*24750 *54,500	*24750 *54,500	*19650 *43,300	*19650 *43,300
-4.6m -15'	*10350 *22,800	9850 21,800			*12100 *26,700	11150 24,600	*16150 *35,600	*16050 *35,400	*21000 *46,200	*21000 *46,200	*27400 *60,400	*27400 *60,400
-6.1m -20'	*9500 *20,900	*9500 *20,900					*11450 *25,200	*11450 *25,200	*15250 *33,700	*15250 *33,700		

\*Load is limited by hydraulic capacity rather than tipping. Ratings are based on SAE standard NO. J1097. Rated loads do not exceed 87% of hydraulic lift capacity or 75% of tipping load.



# LIFTING CAPACITY

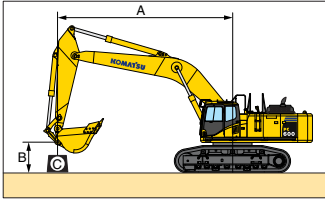

## PC600LC-8R1

- A: Reach from swing center
- B: Bucket hook height
- C: Lifting capacity
- Cf: Rating over front
- Cs: Rating over side
- ☉: Rating at maximum reach

Boom : 7.3m 23'11", Arm : 3.5m 11'6", Bucket : 2.8m<sup>3</sup> 3.66cu.yd, Shoes : 600mm 24" triple, L mode: "ON" unit: kg lb

B	A	☉ MAX		9.1m 29'		7.6m 24'		6.1m 20'		4.6m 15'		3.0m 9'	
		Cf	Cs	Cf	Cs	Cf	Cs	Cf	Cs	Cf	Cs	Cf	Cs
9.1m 29'		*8150 *17,900	*8150 *17,900										
7.6m 24'		*7900 *17,400	*7900 *17,400	*9850 *21,700	9750 21,500								
6.1m 20'		*7950 *17,600	7650 16,800	*12150 *26,800	9600 21,100	*13200 *29,100	*13200 *29,100						
4.6m 15'		*8300 *18,300	6800 15,000	*12900 *28,400	9250 20,400	*14800 *32,600	13000 28,600	*18000 *39,700	*18000 *39,700	*24400 *53,800	*24400 *53,800		
3.0m 9'		*8900 *19,700	6300 13,900	13150 29,000	8850 19,500	*16700 *36,800	12250 27,000	*21550 *47,500	17900 39,400	*26500 *58,400	*26500 *58,400		
1.5m 4'		9450 20,900	6150 13,600	12750 28,100	8450 18,700	*17450 38,500	11650 25,700	*23950 *52,800	16800 37,100	*23400 *51,600	*23400 *51,600		
0m 0'		9700 21,400	6300 13,900	12450 27,400	8200 18,100	16950 37,400	11200 24,700	24750 54,600	16150 35,600	*17800 *39,300	*17800 *39,300		
-1.5m -4'		10400 22,900	6800 14,900	12300 27,100	8050 17,700	16700 36,800	10950 24,100	*24500 *54,000	15800 34,900	*25450 *56,100	*25450 *56,100	*16950 *37,300	*16950 *37,300
-3.0m -9'		11850 26,100	7750 17,100	12300 27,100	8050 17,800	16600 36,600	10900 24,000	*23450 *51,700	15850 34,900	*30700 *67,700	*30700 *67,700	*23750 *52,400	*23750 *52,400
-4.6m -15'		*13350 *29,400	9850 21,800			*15450 *34,100	11150 24,600	*20350 *44,900	16150 35,600	*26250 *57,900	*26250 *57,900	*33500 *73,900	*33500 *73,900
-6.1m -20'		*12450 *27,400	*12450 *27,400					*14750 *32,600	*14750 *32,600	*19500 *43,000	*19500 *43,000		

Boom : 6.6m 21'8", Arm : 2.9m 9'6", Bucket : 3.5m<sup>3</sup> 4.58cu.yd, Shoes : 600mm 24" triple, L mode: "OFF" unit: kg lb

B	A	☉ MAX		9.1m 29'		7.6m 24'		6.1m 20'		4.6m 15'		3.0m 9'	
		Cf	Cs	Cf	Cs	Cf	Cs	Cf	Cs	Cf	Cs	Cf	Cs
9.1m 29'		*9650 *21,300	*9650 *21,300										
7.6m 24'		*9050 *20,000	*9050 *20,000			*11550 *25,500	*11550 *25,500						
6.1m 20'		*8950 *19,700	*8950 *19,700			*11750 *25,900	*11750 *25,900						
4.6m 15'		*9200 *20,300	8400 18,500	*11250 *24,800	9150 20,200	*12700 *28,000	*12700 *28,000	*15450 *34,100	*15450 *34,100	*20100 *44,400	*20100 *44,400		
3.0m 9'		*9800 *21,600	7750 17,100	*11750 *25,900	8850 19,500	*14000 *30,900	12300 27,100	*17950 *39,600	17900 39,500	*24650 *54,300	*24650 *54,300		
1.5m 4'		*10800 *23,800	7600 16,700	*12150 *26,800	8500 18,800	*15000 *33,100	11750 25,900	*19750 *43,500	17050 37,600	*26900 *59,400	26350 58,100		
0m 0'		*11500 *25,400	7800 17,200	*12200 *26,900	8300 18,300	*15500 *34,000	11350 25,000	*20250 *44,600	16400 36,200	*26150 *57,700	25450 56,100		
-1.5m -4'		*11600 *25,600	8550 18,900	*11300 *24,900	8250 18,200	*15000 *33,100	11150 24,600	*19800 *43,600	16100 35,500	*26750 *58,900	*26750 *58,900	*18800 *41,500	*18800 *41,500
-3.0m -9'		*11500 *25,400	10150 22,400			*13250 *29,200	11250 24,800	*17950 *39,600	16250 35,800	*23750 *52,400	*23750 *52,400	*24700 *54,500	*24700 *54,500
-4.6m -15'		*10650 *23,500	*10650 *23,500					*13500 *29,800	*13500 *29,800	*18250 *40,300	*18250 *40,300	*23100 *50,900	*23100 *50,900

Boom : 6.6m 21'8", Arm : 2.9m 9'6", Bucket : 3.5m<sup>3</sup> 4.58cu.yd, Shoes : 600mm 24" triple, L mode: "ON" unit: kg lb

B	A	☉ MAX		9.1m 29'		7.6m 24'		6.1m 20'		4.6m 15'		3.0m 9'	
		Cf	Cs	Cf	Cs	Cf	Cs	Cf	Cs	Cf	Cs	Cf	Cs
9.1m 29'		*11800 *26,000	*11800 *26,000										
7.6m 24'		*11100 *24,400	*11100 *24,400			*14400 *31,800	13700 30,300						
6.1m 20'		*10950 *24,200	9600 21,100			*14700 *32,400	13500 29,800						
4.6m 15'		*11250 *24,800	8400 18,500	13500 29,800	9150 20,200	*15900 *35,100	13000 28,700	*19100 *42,100	*19100 *42,100	*24650 *54,300	*24600 *54,300		
3.0m 9'		11650 25,700	7750 17,100	13150 29,000	8850 19,500	*17500 *38,600	12300 27,100	*22250 *49,000	18050 39,800	*30350 *66,900	28500 62,800		
1.5m 4'		11450 25,300	7600 16,700	12800 28,300	8500 18,800	17550 38,700	11750 25,900	*24450 *54,000	17050 37,600	*26900 *59,400	26350 58,100		
0m 0'		11850 26,100	7800 17,200	12550 27,700	8300 18,300	17150 37,800	11350 25,000	25100 55,300	16400 36,200	*26150 *57,700	25450 56,100		
-1.5m -4'		12950 28,600	8550 18,900	12500 27,600	8250 18,200	16900 37,300	11150 24,600	*24650 *54,300	16100 35,500	*33050 *72,800	26550 58,600	*22500 *49,600	*22500 *49,600
-3.0m -9'		*14750 *32,500	10150 22,400			*16800 *37,000	11250 24,800	*22450 *49,500	16250 35,800	*29500 *65,100	26900 59,300	*31000 *68,400	*31000 *68,400
-4.6m -15'		*13750 *30,400	*13750 *30,400					*17200 *37,900	*16600 *36,600	*23000 *50,800	*23000 *50,800	*29100 *64,200	*29100 *64,200

\*Load is limited by hydraulic capacity rather than tipping. Ratings are based on SAE standard NO. J1097. Rated loads do not exceed 87% of hydraulic lift capacity or 75% of tipping load.



### Backhoe

Specs shown include the following equipment:  
PC600-8R1 : Boom **7660 mm 25'2"**, Arm **3500 mm 11'6"**,  
Bucket **2.7 m³ 3.53 yd³**, Shoes **600 mm 24"** triple grouser

#### 3 Kits Transportation

Work equipment assembly (Backhoe)  
Weight : **12.5 t 13.8 U.S.ton**

Boom

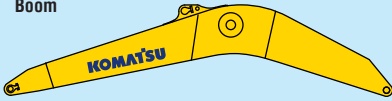

4.9t : **7920 x 2040 x 1190**  
5.4U.S.ton : **26'0" x 6'8" x 3'11"**

Arm

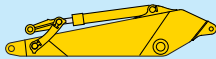

3.3t : **4870 x 1210 x 650**  
3.6U.S.ton : **16'0" x 4'0" x 2'2"**

Bucket



2.5t : **2150 x 1780 x 1780**  
2.8U.S.ton : **7'1" x 5'10" x 5'10"**

Boom cylinder & Arm cylinder



Total **1.7 t 1.9 U.S.ton**

#### 4 Kits Transportation

Work equipment assembly (Backhoe)  
Weight : **12.5 t 13.8 U.S.ton**

Boom



4.9t : **7920 x 2040 x 1190**  
5.4U.S.ton : **26'0" x 6'8" x 3'11"**

Arm

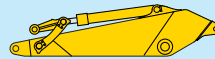

3.3t : **4870 x 1210 x 650**  
3.6U.S.ton : **16'0" x 4'0" x 2'2"**

Bucket



2.5t : **2150 x 1780 x 1780**  
2.8U.S.ton : **7'1" x 5'10" x 5'10"**

Boom cylinder & Arm cylinder



Total **1.7 t 1.9 U.S.ton**

### Loading Shovel

Specs shown include the following equipment:  
PC600-8R1 : Boom **4000 mm 13'1"**, Arm **3000 mm 9'10"**,  
Bucket **4.0 m³ 5.2 yd³**, Shoes **600 mm 24"** double grouser

#### 3 Kits Transportation

Work equipment assembly (Loading shovel)  
Width : **2090 6'10"**  
Weight : **16.5t 18.2U.S.ton**

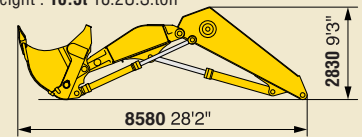

Base machine

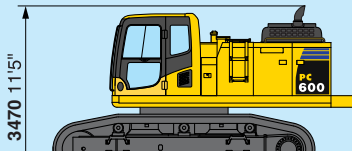

PC600-8R1 **6270 20'7"**  
PC600LC-8R1 **6440 21'2"**  
Width : **3195 10'6"**

Weight : PC600-8R1 **34.4t 37.9U.S.ton**  
PC600LC-8R1 **35.4t 39.0U.S.ton**

Upper structure

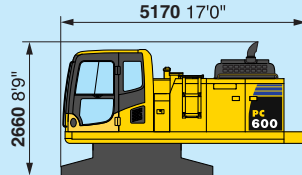

Width : **3170 10'5"**  
Weight : **18.4t 20.3U.S.ton**

Undercarriage

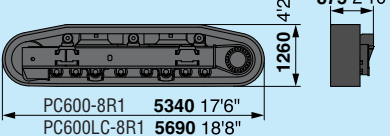

Weight : PC600-8R1 **16.0t [8.0t x 2] 17.6U.S.ton [8.8U.S.ton x 2]**  
PC600LC-8R1 **17.0t [8.5t x 2] 18.7U.S.ton [9.4U.S.ton x 2]**

Base machine

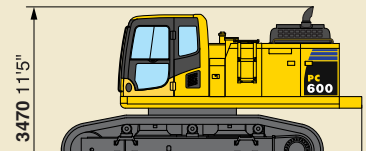

PC600-8R1 **6270 20'7"**  
PC600LC-8R1 **6440 21'2"**  
Width : **3195 10'6"**

Weight : PC600-8R1 **34.4t 37.9U.S.ton**  
PC600LC-8R1 **35.4t 39.0U.S.ton**

Others

Weight : **12.3t 13.6U.S.ton**

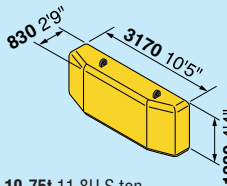

Weight : **10.75t 11.8U.S.ton**

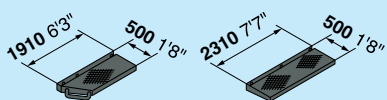

Others

Weight : **12.3t 13.6U.S.ton**

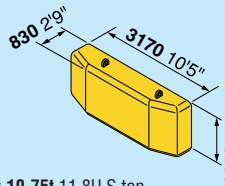

Weight : **10.75t 11.8U.S.ton**

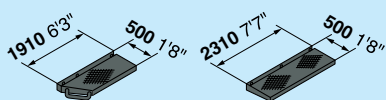

Others

Weight : **12.3t 13.6U.S.ton**

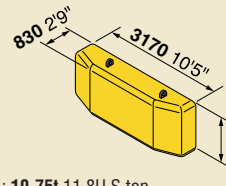

Weight : **10.75t 11.8U.S.ton**

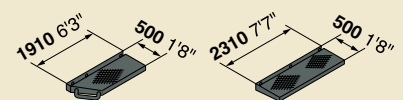



## STANDARD EQUIPMENT

### ENGINE AND RELATED ITEMS:

- Air cleaner, double element, dry
- Engine, Komatsu SAA6D140E-5
- Variable speed cooling fan, with fan guard

### ELECTRICAL SYSTEM:

- Alternator, 50 amp, 24 V
- Auto decelerator and auto idling system
- Batteries, 170 Ah, 2 x 12 V
- Starting motors, 11kW
- Working lights 2 (boom and right front)

### UNDERCARRIAGE:

- Hydraulic track adjusters (each side)
- Sealed track
- 8 track/3 carrier rollers (each side)
- 9 track/3 carrier rollers (each side)(LC)
- **600 mm** 24" triple grouser
- Variable track gauge

### GUARDS AND COVERS:

- Dust-proof net for radiator and oil cooler
- Pump/engine room partition cover
- Strengthened revolving frame underguard
- Travel motor guards

### OPERATOR ENVIRONMENT:

- Cab with pull-up type front window
- Damper mount, all-weather, sound-suppressed cab with tinted safety glass windows, lockable door, intermittent window wiper and washer, floor mat, cigarette lighter and ashtray
- Multi-function color monitor, fuel control dials, service meter, gauges (coolant temperature, hydraulic oil temperature and fuel level), caution lights (electric charge, engine oil pressure, and air cleaner clogging), indicator lights (engine preheating and swing lock light) level check lights (coolant and engine oil level), self-diagnostic system with trouble data memory
- Seat, fully adjustable with suspension
- Rear view mirror (RH)

### HYDRAULIC CONTROLS:

- Control levers and pedals for steering and travel with PPC system
- Control levers, wrist control levers for arm, boom, bucket, and swing with PPC system
- Control valves, 5+4 spools (boom, arm, bucket, swing, and travel)
- Fully hydraulic, with Open-Center Load-Sensing (OLSS) and engine speed sensing (pump and engine mutual control system)
- In-line filter
- Lifting mode system
- Oil cooler
- One axial piston motor per track for travel with counter balance valve
- One gear pump for control circuit
- Power max function
- Two axial piston motors for swing with single-stage relief valve
- Two-mode setting for boom
- Two variable capacity piston pumps

### DRIVE AND BRAKE SYSTEM:

- Brakes, hydraulic lock travel brakes, oil disc parking
- Hydrostatic two travel speed system with planetary triple reduction final drive

### OTHER STANDARD EQUIPMENT:

- Anti-slip plates
- Automatic swing holding brake
- Catwalk
- Counterweight, **10750 kg** 23,700 lb
- Horn, electric
- Large handrails
- Marks and plates, English
- One-touch engine oil drainage
- Paint, Komatsu standard
- PM tune-up service connector
- Rear reflector
- Travel alarm
- Water separator



## OPTIONAL EQUIPMENT

- |   |   |  |
|---|---|--|
| <ul style="list-style-type: none"> <li>● Alternator, 90 amp, 24 V</li> <li>● Arms (Backhoe):           <ul style="list-style-type: none"> <li>—<b>3500 mm</b> 11'6" arm assembly</li> <li>—<b>3500 mm</b> 11'6" HD arm assembly</li> <li>—<b>4300 mm</b> 14'1" arm assembly</li> <li>—<b>5200 mm</b> 17'1" arm assembly</li> <li>—<b>2900 mm</b> 9'6" SE arm assembly</li> </ul> </li> <li>● Automatic air conditioner</li> <li>● Booms (Backhoe):           <ul style="list-style-type: none"> <li>—<b>7660 mm</b> 25'2" boom assembly</li> <li>—<b>7300 mm</b> 23'11" HD boom assembly</li> <li>—<b>6600 mm</b> 21'8" SE boom assembly</li> </ul> </li> <li>● Cab front guard (ISO 10262 level 2)</li> <li>● Cab with fixed front window</li> <li>● Counterweight <b>13500kg</b> 29,800 lb</li> </ul> | <ul style="list-style-type: none"> <li>● Electric pump, grease gun with indicator</li> <li>● 12V electric supply</li> <li>● Fire extinguisher</li> <li>● Full length track roller guard</li> <li>● General tool kit</li> <li>● Interconnected horn and warning light</li> <li>● Large-capacity batteries</li> <li>● Loading shovel attachments</li> <li>● Lower wiper</li> <li>● OPG top guard</li> <li>● Radio AM/FM</li> <li>● Rain visor</li> <li>● Rear view mirror (LH)</li> <li>● Rear view monitoring system</li> <li>● Rock protectors (undercarridge)</li> </ul> | <ul style="list-style-type: none"> <li>● Seat belt <b>78 mm</b> 3", <b>50 mm</b> 2"</li> <li>● Service valve</li> <li>● Shoes:           <ul style="list-style-type: none"> <li>—<b>600 mm</b> 24" double grouser for backhoe</li> <li>—<b>750 mm</b> 29.5" triple grouser for backhoe</li> <li>—<b>900 mm</b> 35.5" triple grouser for PC600LC backhoe only</li> </ul> </li> <li>● Spare parts for first service</li> <li>● Step light with timer</li> <li>● Sun visor</li> <li>● Track frame undercover (center)</li> <li>● Vandalism protection locks</li> <li>● Working lights 2 (on cab)</li> </ul> |
|---|---|--|

www.komatsu.com

Printed in Japan 201502 IP.As

# KOMATSU®

CEN00426-02

Materials and specifications are subject to change without notice.  
**KOMATSU** is a trademark of Komatsu Ltd. Japan.